



**Operating Instructions
for
Temperature Sensor**

Model: TTL

Explosion Proof Protection Ex d



1 Contents

1	Contents	2
2	Note	3
3	Instrument Inspection	3
4	Regulation Use	3
5	Operating Principle	4
6	Use in hazardous Areas.....	4
6.1	Area of validity.....	4
6.2	Guidelines	4
6.3	General	5
6.4	Protection against E.S.D. (Electrostatic Discharge)	5
6.5	Maintenance and repairs.....	5
6.6	Storage.....	6
7	Description of the Factory Label	6
8	Installation in the classified area	7
8.1	Examples of installation in explosion-proof areas conform to the protection type “Ex d”	7
9	Technical Details.....	8
9.1	Sensor and accuracy	8
	Type Class Temp. range Limiting error	8
9.2	General details.....	9
9.3	Materials.....	9
9.4	Process connection.....	9
9.5	ATEX-approval	9
9.6	Head transmitter.....	9
9.7	Display	9
10	Dimensions.....	10
10.1	Sensors.....	10
10.2	Thermowells.....	11
10.3	Lagging extension at thermowell “T”.	16
11	Order details	17
12	EU-Certificates.....	19
13	ATEX-Certificates	20
14	Note	25

Manufactured by:

Kobold Mesura S.L.U
Avd. Conflent 68 nave 15
08915 Badalona
Tel.: +34 93 460 38 83
Fax: +34 93 460 38 76
E-Mail: info.es@kobold.com
www.kobold.com
Edition Oct. 2022

2 Note

Please read these operating instructions before unpacking and putting the unit into operation. Follow the instructions precisely as described herein.

The instruction manuals on our website www.kobold.com are always for currently manufactured version of our products. Due to technical changes, the instruction manuals available online may not always correspond to the product version you have purchased. If you need an instruction manual that corresponds to the purchased product version, you can request it from us free of charge by email (info.de@kobold.com) in PDF format, specifying the relevant invoice number and serial number. If you wish, the operating instructions can also be sent to you by post in paper form against an applicable postage fee.

Operating instructions, data sheet, approvals and further information via the QR code on the device or via www.kobold.com

The devices are only to be used, maintained and serviced by persons familiar with these operating instructions and in accordance with local regulations applying to Health & Safety and prevention of accidents.

When used in machines, the measuring unit should be used only when the machines fulfil the EC machinery directive.

3 Instrument Inspection

Instruments are inspected before shipping and sent out in perfect condition.

Should damage to a device be visible, we recommend a thorough inspection of the delivery packaging. In case of damage, please inform your parcel service / forwarding agent immediately, since they are responsible for damages during transit.

Scope of delivery:

The standard delivery includes:

- Device model: TTL

4 Regulation Use

The temperature sensors of series TTL are suitable for all applications where processes involving fluids, solid bodies or materials, or gases, require temperature recording and measurement. Our temperature sensors are suitable for use in the following industrial areas: chemicals, petrochemicals, water, feed, food, sanitary, etc.

Any use of the Temperature Sensor, model: TTL, which exceeds the manufacturer's specification may invalidate its warranty. Therefore, any resulting damage is not the responsibility of the manufacturer. The user assumes all risk for such usage.

5 Operating Principle

Thermocouples use the Seebeck effect, state that a voltage is generated at the point of contact of two different metals.

Electrical conductors of different metals or metal alloys are connected by punctiform welding. A thermal e.m.f. is generated at the free ends (point of connection) by heating this junction (measuring junction). The free ends are extended to a point with known temperature (reference junction) by means of compensating leads. The temperature difference between measuring junction is measured with thermocouples.

6 Use in hazardous Areas

6.1 Area of validity

These security instructions apply to TTL Series temperature sensors and their accessories for use in explosion-proof atmospheres conform to **CE certificate LOM 08ATEX2016 X**

6.2 Guidelines

The TTL Series temperature measuring instruments work according to Seebeck effect principle. This measuring principle acts to check and measure the temperature also in explosion-proof areas.

TTL devices can be with a standard 4 to 20 mA signal transmitter, Hart protocol, Profibus/Fieldbus or with direct access to the sensor. They are appropriate for use in Group IIC and Categories 2G/D explosion-proof atmospheres.

The sensor element can be installed in Category 2 explosion-proof areas in accordance with Certification 2G Ex d. The mechanical connecting element to the process can be installed in Category 2 explosion-proof areas, conform to Certification 2G Ex d.

Devices labelled “Ex d” which have a mechanical separating element, such as a thermowell, are approved for Zone 0/20 to Zone 1/21, when using a sensor certified as 2GD.

The temperature class and/or the surface temperature relates solely to a device operated at ambient temperature. On installation the actual temperature class for process operation must be determined.

The inlet bushings used must conform to the certification for their type in accordance with the directive.

The requirements of Regulation 2014/34/EU, and the applicable national regulations for the use of measuring instruments in explosion-proof areas, such as

EN 60079-0, EN 60079-1, EN 61241-1 and other regulations relating to this certification type, must be fulfilled.

Only qualified specialist personnel may install devices in explosion-proof areas.

6.3 General

- When installing the sensor it is necessary to follow all the instructions and regulations for explosion-proof areas and the safety instructions included in these instructions.
- Make sure that the details on the sensor's type label correspond to the working conditions for the application.
- When installing the device, make sure you do not create any mechanical deformation as a result of solder spots or the application of mechanical force.
- **Important:** Make sure there is an electrical connection between the device's earth and the earth of the system.
- Make sure the lid is closed before putting the device into operation.
- Before re-opening the lid, remove the plug from the mains or de-energise the device and make sure there is no danger of explosion.
- Only use cable glands according to norms for Ex d protection.
- **Important:** Due to the use of a flame path and its fit tolerance it is not permissible to use standard measuring inserts as spare parts

6.4 Protection against E.S.D. (Electrostatic Discharge)

Temperature sensors with plastic parts that can become electrically charged bear a warning label. Electrical charging must be avoided at all costs. Pay attention to the following:

- Avoid rubbing the device
- Never clean the device dry
- Do not install the device near material airflows or near steam outlets

6.5 Maintenance and repairs

The instrument does not require maintenance or servicing.
Repairs must be only carried out by Kobold Mesura (manufacturer)

6.6 Storage

Measuring instruments should be protected against humidity and dust.
Storage temperature: -40°C....+85°C for sensors without transmitter.
Storage temperature: See manual of the corresponding transmitter and display model.

7 Description of the Factory Label

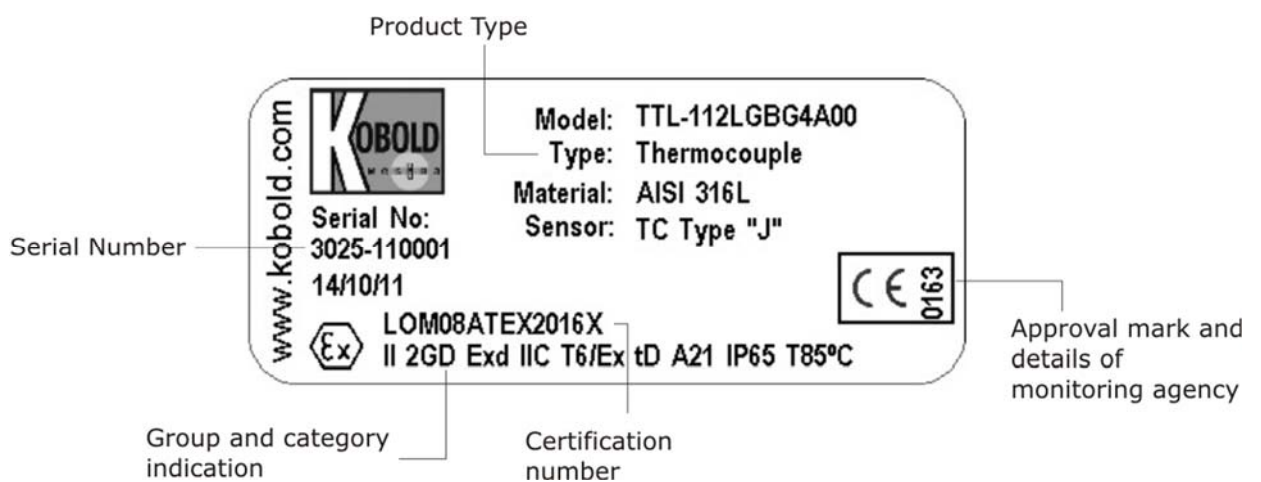

8 Installation in the classified area

8.1 Examples of installation in explosion-proof areas conform to the protection type "Ex d"

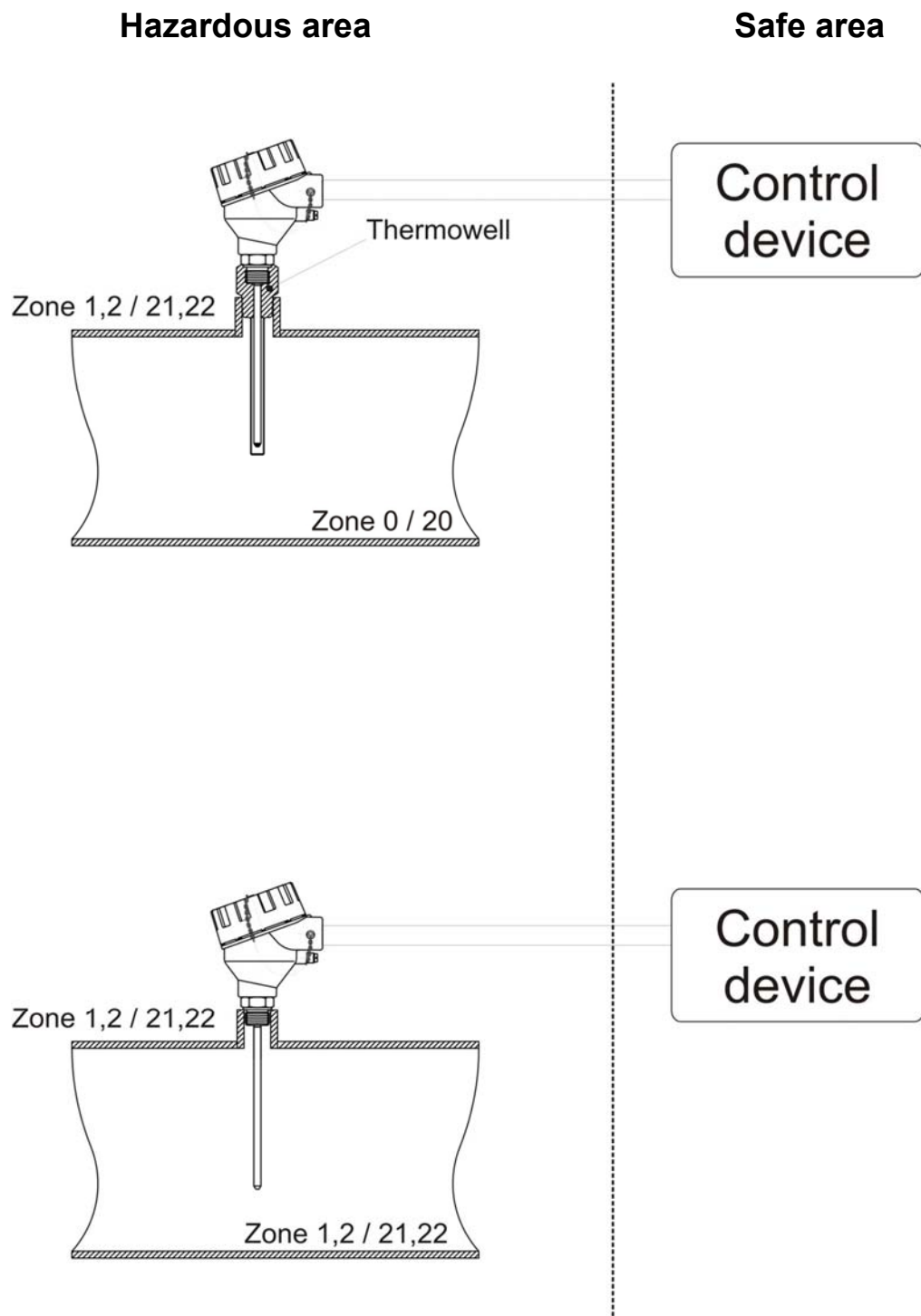

9 Technical Details

9.1 Sensor and accuracy

Type Class Temp. range Limiting error

IEC 60584.2

K	1	-40°C...+375°C	±1,5°C
K	1	+375°C...+1000°C	±0,0040 x (t°)
K	2	-40°C...+333°C	±2,5°C
K	2	+333°C...+1200°C	±0,0075 x (t°)

ISA (ANSI) MC96.1-1982

K	Standard	0°C...+1250°C	±2,2°C or ±0,75 %
K	Special	0°C...+1250°C	±1,1°C or ±0,4 %

IEC 60584.2

E	1	-40°C...+375°C	±1,5°C
E	1	+375°C...+800°C	±0,0040 x (t°)
E	2	-40°C...+333°C	±2,5°C
E	2	+333°C...+1200°C	±0,0075 x (t°)

IEC 60584.2

N	1	-40°C...+375°C	±1,5°C
N	1	+375°C...+1000°C	±0,0040 x (t°)
N	2	-40°C...+333°C	±2,5°C
N	2	+333°C...+1200°C	±0,0075 x (t°)

IEC 60584.2

J	1	-40°C...+375°C	±1,5°C
J	1	+375°C...+750°C	±0,0040 x (t°)
J	2	-40°C...+333°C	±2,5°C
J	2	+333°C...+750°C	±0,0075 x (t°)

ISA (ANSI) MC96.1-1982

J	Standard	0°C...+750°C	±2,2°C or ±0,75 %
J	Special	0°C...+750°C	±1,1°C or ±0,4 %

IEC 60584.2

T	1	-40°C...+125°C	±0,5°C
T	1	+125°C...+350°C	±0,0040 x (t°)
T	2	-40°C...+133°C	±1°C
T	2	+133°C...+350°C	±0,0075 x (t°)

For type K there is a risk of blue mould forming between 850°C and 950°C so we recommend to use a type N if the working temperature is continuously in this range

9.2 General details

Ambient temperature:	-40...+150°C with ceramic terminal base -40... +85°C with transmitter
Process temperature:	máx. 750°C (other on request)
Operating pressure:	250 bar (depending on thermowell)
Connection head:	form XD (IP54...IP68 depending on cable gland and sealing "not included" M20 x 1,5 mm)

9.3 Materials

Sensor:	st. st. 1.4404 (type J), alloy 600 (type K)
Thermowell:	st. st. 1.4404 (others on request)
Neckpipe:	st. st. 1.4404 (others on request)
Connection head:	Aluminium painted (others on request)
Terminal base:	Ceramic (without transmitter)

9.4 Process connection

Thread:	G1/2", G3/4, G1", 1/2" NPT, 3/4" NPT, 1" NPT
Din-flange:	DN 15, 20, 25, 32, 40, 50
Ansi flange:	1/2", 3/4", 1", 1 1/2", 2"
Weld-in:	3/4", 1", 1 1/4"

9.5 ATEX-approval

 II 2 GD Exd IIC T6 / Ex tD A21 IP65 T85 °C

9.6 Head transmitter

- Output:	analogue output 4...20 mA
- Communication:	HART®-protocol PROFIBUS®/Fieldbus
- Minimum meas. span:	standard transmitter 25°K transmitter with HART® 10°K transmitter with PROFIBUS®/Fieldbus 5°K
- Supply voltage:	7,5...45 Vdc for standard transmitter and transmitter with Hart 9...32 Vdc for transmitter with PROFIBUS®/Fieldbus

9.7 Display

- Only for 4...20 mA or Hart transmitter.	
- Type:	4-digit LCD or LED
- Supply:	loop powered
- Voltage drop out:	LCD max. 2,5 Vdc LED 3,3 V at 4 mA, 3,7 V at 20 mA

Note

For programming of transmitter and display please refer to their separate programming manuals.

10 Dimensions

10.1 Sensors

Dimensions Temperature Sensor TTL-1

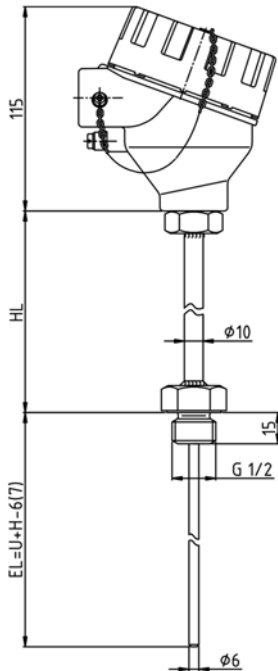

Dimensions Temperature Sensor TTL-2

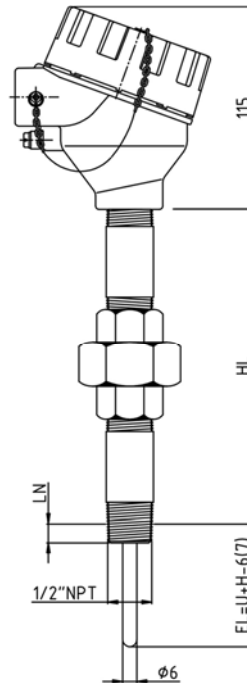

HL: Neckpipe length 130 mm TTL-1 (other on request)
 150 mm TTL-2 (other on request)
 LN: Screw-in-length by hand (approx. 8,1 mm at 1/2"NPT)

U: Immersion length thermowell (see drawing thermowell)
 H: Length thermowell (see drawing thermowell)
 EL: Immersion length
 EL: U+H-7 mm for thermowell type B
 EL: U+H-8 mm for thermowell type G and D

Measuring Insert TTL-3

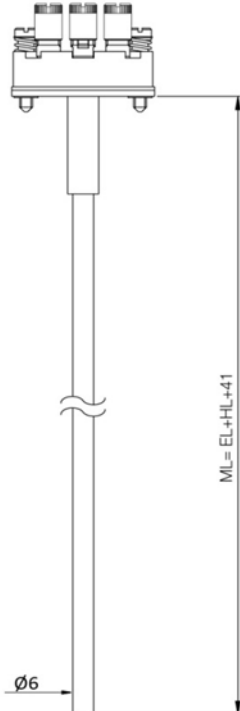

IMPORTANT!!
 * Due to the use of a flame path and its fit tolerance it is no permissible to use standard measuring inserts as spare parts.

HL = neckpipe length
 EL = immersion length
 ML = measuring insert length

Dimensions Connection Head with Display

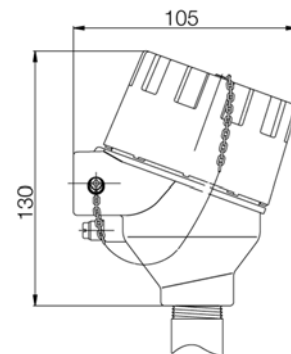

10.2 Thermowells

Dimensions Thermowell Model TTL-...B...

Nominal pressure: max. PN25 at 20°C
Cylindrical thermowell, welded,
with process connection G-thread

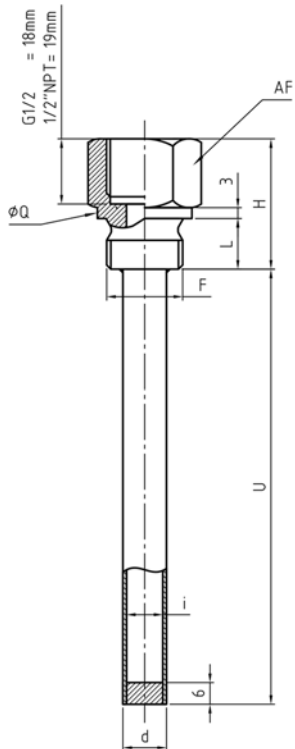

Process Connection	Max. Total length	AF	F	i	d	H	L	Q
G-thread	5000 mm	27	G 1/2 B	10	12	36	14	26
				12	14			
		36	G 3/4 B	10	12	38	16	31.7
				12	14			
		41	G 1 B	10	12	40	18	39
				12	14			

Nominal pressure: max. PN25 at 20°C
Cylindrical thermowell, welded,
with process connection NPT- thread

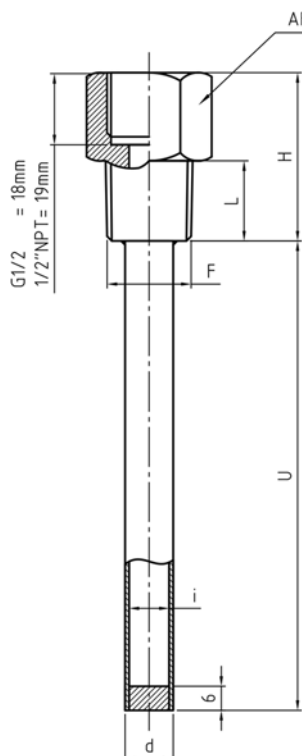

Process Connection	Max. Total length	AF	F	i	d	H	L
NPT-thread	5000 mm	27	1/2 NPT	10	12	42	20
				12	14		
		27	3/4 NPT	10	12	43	24
				12	14		
		36	1 NPT	10	12	46	24
				12	14		

Nominal pressure: max. PN6..40 at 20°C
 Cylindrical thermowell, welded, with process connection flange acc. DIN or ANSI

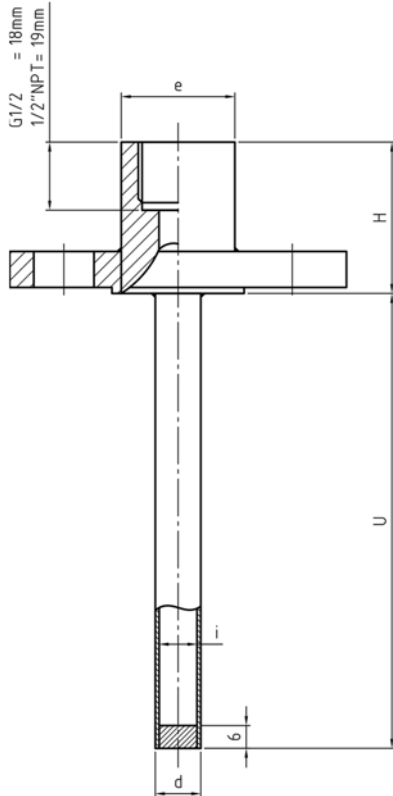

Process connection		Max. Total Length	i	d	H	e
With flange	ANSI 1/2"	5000mm	10/12	12/14	40	30
	ANSI 3/4"					
	ANSI 1"					
	ANSI 1 1/2"					
	ANSI 2"					
	DIN DN 15	10/12	12/14	40	30	
	DIN DN 20					
	DIN DN 25					
	DIN DN 32					
	DIN DN 40					
DIN DN 50				35		

Dimensions Thermowell Model TTL-...G...

Nominal pressure: max. PN100 at 20°C
 Cylindrical thermowell out of solid material with stepped shaft and process connection G-thread

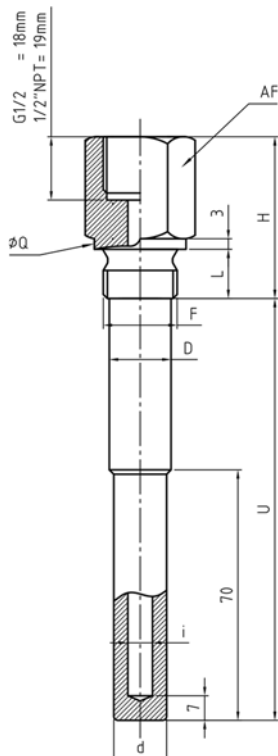

Process Connection	Max. Total Length	AF	F	i	d	D	H	L	Q
G-thread	1000mm	27	G 1/2 B	7-8-9	15	17.5	46	14	26
				10-12	17,5	17,5			
		36	G 3/4 B	7-8-9	15	18	16	31.7	
				10-12	18	21			
		41	G 1 B	7-8-9	15	21	51	18	39
				10-12	18	25			

Nominal pressure: max. PN100 at 20°C
 Cylindrical thermowell out of solid material with stepped shaft and process connection NPT-thread

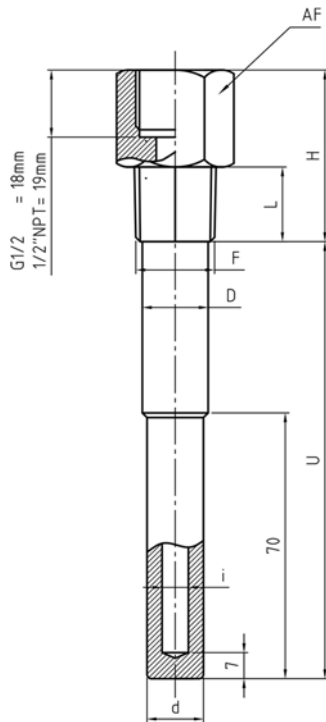

Process Connection	Max. Total Length	AF	F	i	d	D	H	L
NPT-thread	1000mm	27	½ NPT	7-8-9	15	17.5	46	20
				10-12	17,5	17,5		
		27	¾ NPT	7-8-9	15	18	51	24
				10-12	18	21		
		36	1 NPT	7-8-9	15	21	51	24
				10-12	18	25		

Nominal pressure: as flange rating (max. PN100 at 20°C)
 Cylindrical thermowell out of solid material with stepped shaft and process connection flanges acc. DIN or ANSI

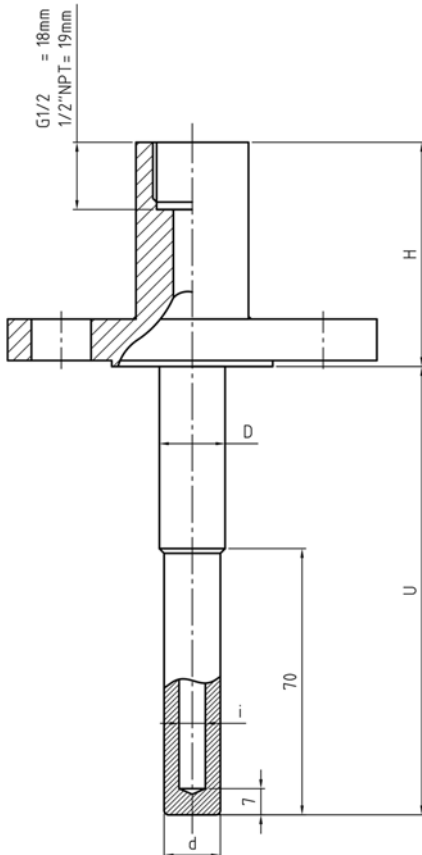

Process Connection	Max. total Length	i	d	D	H	e		
Flange	1000mm	7-8-9	15	17.5	60	30		
							10-12	17,5
		7-8-9	15	18		35		
							10-12	18
		7-8-9	15	21		60	35	
								10-12
		7-8-9	15	17.5	60		30	
								10-12
		7-8-9	15	18			35	
								10-12
		7-8-9	15	21		60	35	
								10-12
		7-8-9	15	21	60		35	
								10-12
		7-8-9	15	21			60	35
7-8-9	15	21	60	35				
						10-12		18

Nominal pressure: PN100 at 20°C
Cylindrical thermowell out of solid material with stepped shaft and process connection for weld-on

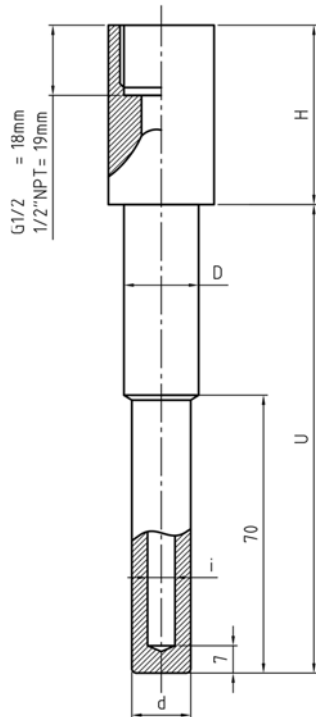

Process Connection		Max. Total Length	F	i	d	D	H
For weld-on	DN 3/4"	1000mm	26,9	7-8-9	15	19	46
				10-12	18		
	DN 1"		33.4	7-8-9	15	22	51
				10-12	18		

Dimensions Thermowell Model TTL-...D...

Nominal pressure: PN250 at 20°C
Conical thermowell out of solid material with process connection G-thread

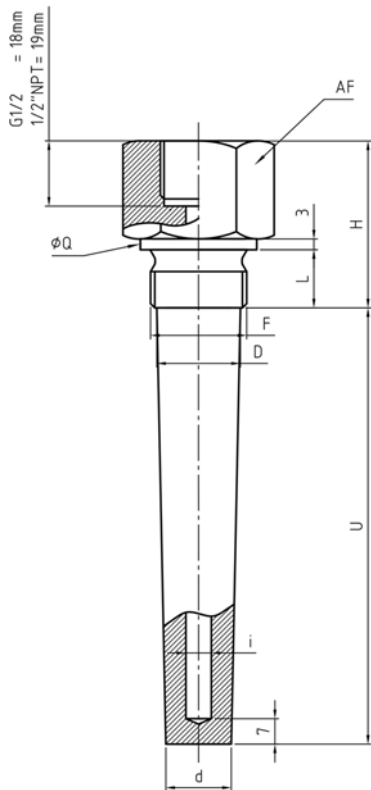

Process Connection	Max. Total Length	AF	F	i	d	D	H	L	Q
G-thread	1000mm	36	G 3/4 B	7-8-9	18	23	46	20	31.7
				10-12	21				
		41	G 1 B	7-8-9	18	29	51	25	39
				10-12	21				

Nominal pressure: PN250 at 20°C
 Conical thermowell out of solid material with
 process connection NPT-thread

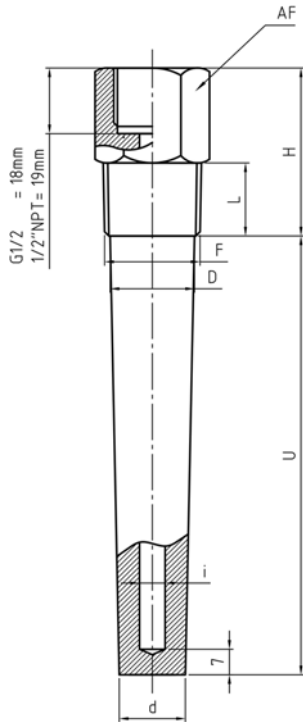

Process Connection	Max. Total Length	AF	F	i	d	D	H	L
NPT-thread	1000mm	27	3/4 NPT	7-8-9	18	23	46	20
				10-12	21			
		36	1 NPT	7-8-9	18	29	51	24
				10-12	21			

Nominal pressure: as flange rating (max. PN250 at 20°C)
 Conical thermowell out of solid material with
 process connection flange acc, DIN or ANSI

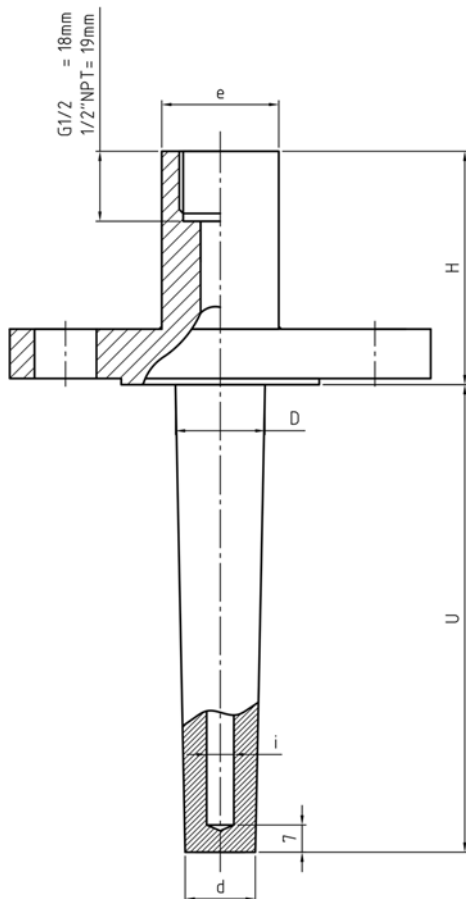

Process Connection	Max. Total Length	i	d	D	H	e		
Flange	1000mm	7-8-9	18	23	60	30		
						10-12	21	
		7-8-9	18	29		60	35	
							10-12	21
		7-8-9	18	23			60	30
								10-12
		7-8-9	18	29	60			35
								10-12
		7-8-9	18	29		60		35
								10-12
		7-8-9	18	29			60	35
								10-12

Nominal pressure: PN250 at 20°C
 Conical thermowell out of solid material with
 process connection flange acc. DIN or ANSI

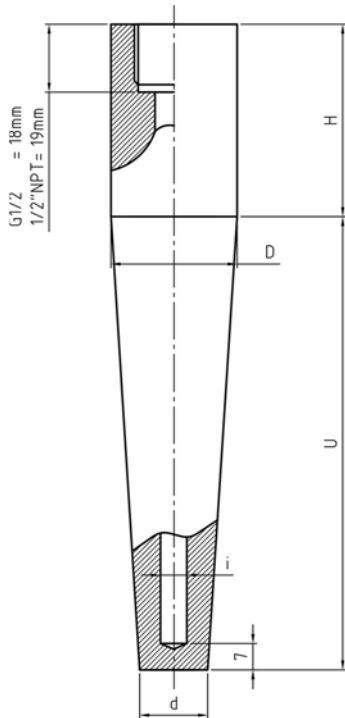

Process Connection		Max. Total Length	i	d	D	H
For weld-on	DN 1"	1000mm	7-8-9	18	33.4	51
			10-12	21		
	DN 1 1/4"		7-8-9	18	38.1	51
			10-12	21		

10.3 Lagging extension at thermowell "T".

In case of ordering with lagging extension at thermowell please see drawing and specify length "T" (total length is "T" + "H"). "H" is fix.

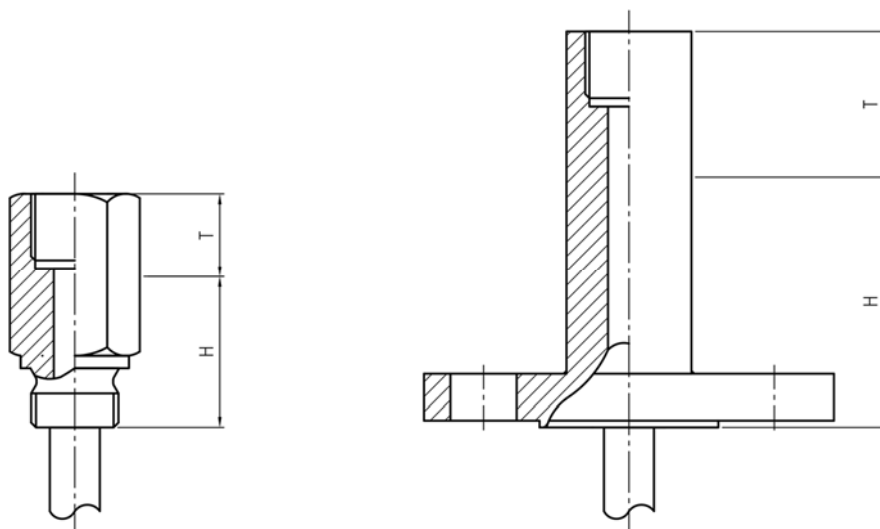

11 Order details

Order Details (example: TTL-232BND A86A2)

Model	Sensor specification				Sensor connection
	Sensor type	Sensor type/cat. /material	Sensor wiring	Connection head/transmitter	
TTL-	0= without	0= without	0= without	0= without	N ¹⁾ =1/2" NPT male G= G1/2" male X= special 0= without
	1= standard 2= with nipple and union X= special	1= 1 x type J, cl. 2; 1.4404 2= 2 x type J, cl. 2; 1.4404 3= 1 x type K, cl. 2; alloy 600 4= 2 x type K, cl. 2; alloy 600 5= 1 x type J, cl. 1; 1.4404 6= 2 x type J, cl. 1; 1.4404 7= 1 x type K, cl. 1; alloy 600 8= 2 x type K, cl. 1; alloy 600 X= special	2= 2-wire	L= without transmitter A= with programmable 2-wire transmitter B= with 2-wire transmitter HART® protocol C= with transmitter Profibus®/ Fieldbus	
	3= measuring insert				0= without

Order Details continued:

Thermowell specification				Length (meas. Insert, sensor, thermowell) ³⁾	Special option
Thermowell type	Process connection	Process connection size	Nominal pressure ⁵⁾ (process connection)		
0 = without	0 = without	0 = without	0 = without	Only for TTL-0 (only thermowell) 0 = without lagging extension "T" 1 = with lagging extension "T" Sensor with thermowell (only for TTL-1/TTL-2) A = with standard neckpipe "HL" and without lagging extension "T" B = with standard neckpipe "HL" and with lagging extension "T" C ⁴⁾ = without neckpipe "HL" and with lagging extension "T" E = with special neckpipe "HL" length and with lagging extension "T" F = with special neckpipe length "HL" and without lagging extension "T" Sensor without thermowell (only TTL-1/TTL-2) G = with standard neckpipe "HL" H = with special neckpipe "HL" J = without neckpipe length "HL" X = special option (specify in clear text) Only TTL-3 M = measuring insert (only for TTL-3, specify length "ML")	0 = without 1 ⁶⁾ = with LCD Display 2 ⁶⁾ = with LED display Y = special option (specify in clear text)
B = cylindrical, multipart, welded G = cylindrical, bar stock/drilled with stepped shank D = tapered shank, bar stock/drilled X = special option	G = G-thread	4 = 1/2" 5 = 3/4" 6 = 1" Y = special	A = PN25 (only for thermowell type B) B = PN100 (only for thermowell type G) C = PN250 (only for thermowell type D)		
	N = NPT-thread	4 = 1/2" 5 = 3/4" 6 = 1" Y = special	A = PN25 (only for thermowell type B) B = PN100 (only for thermowell type G) C = PN250 (only for thermowell type D)		
	S ²⁾ = welded	5 = 3/4" 6 = 1" 7 = 1 1/4" Y = special	B = PN100 (only for thermowell type G) C = PN250 (only for thermowell type D)		
	F = DIN flange	4 = DN15 5 = DN20 6 = DN25 7 = DN32 8 = DN40 9 = DN50 Y = special	1 = PN6 2 = PN16 3 = PN40 4 = PN100 Y = special		
	A = ANSI flange	4 = 1/2" 5 = 3/4" 6 = 1" 8 = 1 1/2" 9 = 2" Y = special	5 = 150 lbs 6 = 300 lbs 7 = 600 lbs 8 = 900 lbs (not for 1/2") 9 = 1500 lbs (not for 1/2") Y = special		

- 1) choose N for TTL-2
- 2) not for thermowell type B
- 3) immersion length "U" and hole dia. "i" (when ordering a/with thermowell) or "EL" (when ordering without thermowell), neckpipe length "HL" (when different from stdd. i.e. for TTL-1 stdd. Is 130 mm, for TTL-2 standard is 150 mm), lagging extension "T" (when ordering) and measuring insert length "ML" (when ordering TTL-3) must be specified in clear text when ordering. Pls. check lengths very precisely in order to ensure a perfect match between sensor and thermowell.
- 4) not for TTL-2
- 5) display only available for 4...20 mA or Hart transmitters.

NOTE: Nominal pressure for TTL-3 and sensors without thermowell is atmospheric pressure.

Order Details for ordering only the thermowell (example: TWL-0000NDA8600)

Model	Sensor specification				
	Sensor type	Sensor type/cat.	Sensor wiring	Connection head/transmitter	Sensor connection
TWL-	0 = without	0 = without	0 = without	0 = without	N ¹ =1/2" NPT male G= G1/2" male X= special

- 1) choose N for TTL-2

Order Details for ordering only the thermowell continued:

Thermowell specification				Length (meas. Insert, sensor, thermowell) ¹⁾	Special option
Thermowell type	Process connection	Process connection size	Nominal pressure (process connection)		
Please use the specification codes according to order table shown on page 12				0 = without lagging extension "T" 1 = with lagging extension "T"	0 = without Y = special option (specify in clear text)

- 1) immersion length "U" , hole dia. "i" and lagging extension "T" must be specified in clear text when ordering. Pls. check lengths very precisely in order to ensure a perfect match between sensor and thermowell.

12 EU-Certificates

DECLARACIÓN DE CONFORMIDAD EU

EU DECLARATION OF CONFORMITY
EU-KONFORMITÄTSEKTLÄRUNG
DÉCLARATION DE CONFORMITÉ
DICHIARAZIONE DI CONFORMITÀ EU

KOBOLD MESURA SLU
Avda. Conflent 68 nave 15 08915 Badalona (España)

Declara, bajo la propia responsabilidad, que el producto

*Declares under our sole responsibility, that the product
Erklärt in alleiniger Verantwortung, dass das produkt
Déclare sous sa seule responsabilité, que le produit
Dichiara sotto la propria responsabilità, che il prodotto*

TTL-1..... TTL-X.....
TTL-2.....

A los cuales se refiere esta declaración, son conformes a las siguiente Directivas Europeas:

*To which this declaration relates is in conformity with the following European Directives:
Mit folgenden Richtlinien Konform ist:
À auxquels se réfère cette déclaration, ils sont conformes aux Directives Européennes suivant :
A ai quali si riferisce questa dichiarazione, sono conformi alle direttive europee seguente:*

EMC2014/30/EU LVD2014/35/EU Atex2014/34/EU RoHS2011/65/EU

Normas armonizadas y documentos de la normativa aplicados:

*Applied harmonised standards and normative documents:
Angewandte harmonisierte Normen oder normativer Dokumente:
Normes harmonisées et documents normatifs appliqués :
Norme armonizzate e documenti normativi applicati:*

EN 61010-1:2011 EN 60079-1:2004 (acc.EN 60079-1:2015)
EN 61000-6-2:2006 EN 61241-1:2004 (acc. EN 60079-31:2016)
EN 60079-0:2006 (acc. EN 60079-0 :2013)

Certificado de examen CE de tipo

*EC-type examination certificate
EG-baumusterprübescheinigung
Attestation d'examen CE de type
Certificazione per esame di tipo CE*

Marcado

*Marking
Kennzeichnung
Inscription
Marcatura*

LOM 08ATEX2016 X



II 2 GD Exd IIC T6 / Ex tD A21 IP65 T85 °C

Fabricado en: KOBOLD MESURA SLU Avd. Conflent 68 nave 15 08915 BADALONA (Spain)

*Made in:
Hergestellt in:
Fabriqué dans:
Fabbricato in:*

Organismo notificado : LOM 0163

*Notified organism
Zertifizierungsstelle
Organization annoncée
Organismo informato*

Número notificación : LOM 05ATEX9070

*Number notification
Zertifikatsnummer
Nombre notification
Notifica di numero*

Badalona july. 2013

Gerente

Azzam Charmand

13 ATEX-Certificates



LABORATORIO OFICIAL J. M. MADARIAGA



(1) EC-TYPE EXAMINATION CERTIFICATE

(2) Equipment or protective system intended for use in potentially explosive atmospheres
Directive 94/9/EC

(3) EC-Type Examination Certificate nr **LOM 08ATEX2016 X**

(4) Equipment or protection system **Temperature sensors**
Types TWL... and TTL...

(5) Applicant **KOBOLD MESURA, S.L.U.**

(6) Address **Grifé, 655**
08918- Badalona (BARCELONA)
ESPAÑA

(7) This equipment or protective system and any acceptable variation thereto is specified in the schedule to this certificate and the documents therein referred to.

(8) Laboratorio Oficial J.M. Madariaga (LOM), notified body number 0163 in accordance with Article 9 of the Directive 94/9/EC of the European Parliament of 23 March 1994, certifies that this equipment or protective system has been found to comply with the Essential Health and Safety Requirements relating to the design and construction of equipment and protective systems intended for use in potentially explosive atmospheres, given in Annex II to the Directive.
The examination and test results are recorded in confidential report nr. **LOM 07.165 PP**

(9) Compliance with the Essential Health and Safety Requirements has been assured by compliance with:

Standards	EN 60079-0:2006	EN60079-1:2004
	EN 61241-0:2006	EN61241-1:2004

(10) If the sign X is placed after the certificate number, it indicates that the equipment or protective system is subject to special conditions for safe use specified in the schedule to this certificate.

(11) This EC-Type Examination Certificate relates only to the design and construction of this specified equipment or protective system in accordance with the Directive 94/9/EC. Further requirements of the Directive apply to the manufacture and supply of this equipment or protective system. These are not covered by this certificate.

(12) The marking of the equipment or protective system shall include the following:

II 2 GD Ex d IIC T6
-20 °C ≤ Ta ≤ +60 °C

Madrid, 28th March 2008

Carlos Fernández Ramón
DIRECTOR OF THE LABORATORY

Angel Vega Remesal
Head of the ATEX

This Certificate is a translation from the original in Spanish. The LOM liability applies only on the Spanish text

(This document may only be reproduced in its entirety and without any change)

Page 1 / 3

UNIVERSIDAD POLITÉCNICA DE MADRID
ENSAYOS E INVESTIGACIONES DE MATERIALES Y EQUIPOS PARA ATMÓSFERAS EXPLOSIVAS Y MINERÍA
(Real Decreto 334/1992 de 3 de Abril - BOE 1992-04-29)

Alenza, 1 - 28003 MADRID • (34) 91 4421366 / 91 3367009 • (34) 91 4419933 • lom@lom.upm.es



LABORATORIO OFICIAL J. M. MADARIAGA

(A1) SCHEDULE

(A2) EC-Type Examination Certificate: LOM 08ATEX2016 X

(A3) Description of equipment or protective system

Temperature sensors based on thermocouple (TTL series) or thermoresistor RTD (TWL series) having a head in three formats and a sheath that contains the sensor element. Also is included an ambient thermometer (ST head) that uses a metallic enclosure.

Sensors with their heads are foreseen to be used in combustible dust explosive atmospheres.

The variants having the head type L can be used in gas explosive atmospheres of the group IIC. These variants have a head type XD-AD.. with component certificate FTZÚ 03 ATEX 0074U.

Sensors can be connected either directly or indirectly by means transmitters placed into the head. They can be used any type of electronic transmitter but the internal free volume must be greater than 40% of any cross section y the its internal dissipated power is limited to 15 W

Type codification:

T L

Generic reference(series)

TWL or TTL

Sub-type

Immersion length

Process connection type

Type and number of sensor element

RTD wiring (only TWL series)

Head type

Head types BR1, BR2, B and L

ST variant is used as ambient thermometer

Transmitter type

0 = without transmitter

E = with transmitter

Sheath diameter

Type of protection

E3 = combustible dusts

E4 = gases and combustible dusts

Option code



RCPCR 07.3/2

This Certificate is a translation from the original in Spanish. The LOM liability applies only on the Spanish text

(This document may only be reproduced in its entirety and without any change)



LABORATORIO OFICIAL J. M. MADARIAGA

(A1) SCHEDULE

(A2) EC-Type Examination Certificate: LOM 08ATEX2016 X

(A4) Test report nr LOM 07.165 PP

(A5) Special conditions for safe use

The marked temperature class or surface temperature only refers to the equipment operating ambient temperature. It must be determined the real process temperature in the installation. Head temperature must not be greater than 60 °C

(A6) Individual tests

Each flameproof manufactured unit, including threaded flameproof joint sheaths, must be submitted to static pressure test at 20 bar according 15.1.3 of EN 60079-1:2004.

(A7) Essential Health and Safety Requirements

Explosion safe requirements are covered by application of the standards indicated in page 1/3 of this certificate.

(A8) Descriptive Documents

	Rev.	Date
- Technical description nr.:	DT0315	2008-02-25
- Technical manuals nr.:	CT3225	2008-02-25
	CT3226	2008-02-25
- Drawings nr.:	PM0507R0	2007-10-23
	PM0508R0	2007-10-23
	PM0509R0	2007-10-23
	PM0510R0	2007-10-23
	PM0511R0	2007-10-23
	PM0512R0	2007-10-23
	PM0529R0	2007-10-23
	PM0530R0	2007-10-23
	PM0531R0	2007-10-23
	PM0532R0	2007-10-23
	PM0533R0	2007-10-23
	PM0534R0	2007-10-23
	PM0535R0	2007-10-23
	PM0536R0	2007-10-23
	PM0537R0	2007-10-23
	PM0538R0	2007-10-23
	PM0539R0	2007-10-23
	PM0540R0	2007-10-23
	DT0340	2008-01-02
	DT0342	2008-01-02
	DT0316	2008-01-02



ROPER 07/3/2

This Certificate is a translation from the original in Spanish. The LOM liability applies only on the Spanish text.

(This document may only be reproduced in its entirety, and without any change)



LABORATORIO OFICIAL J. M. MADARIAGA



(1) EC-TYPE EXAMINATION CERTIFICATE SUPPLEMENT

(2) Equipment or protective system intended for use in potentially explosive atmospheres
Directive 94/9/EC

(3) Supplement nr. 1 to EC-Type Examination Certificate number **LOM 08ATEX2016 X**

(4) Equipment or protection system Temperature sensors
Types TWL..., TTL...

(5) Applicant **KOBOLD MESURA, S.L.U.**

(6) Address **Guirifé, 665
08918 BADALONA (BARCELONA)
SPAIN**

(7) Test report nr. **LOM 09.496 GP**

(8) Variations included in this certificate

To update de type codification:

Variants with type of protection Ex d

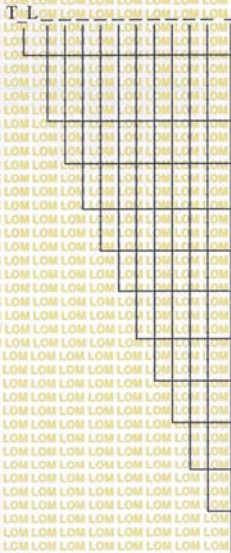

General code (type)

TWL or TTL

Sub-type

Type and number of elements

Sensor wiring

Head type and transmitter

Process connection (Sensor)

Type of thermowell

Process connection (Thermowell)

Process connection (size)

Nominal pressure (Process connection)

Immersion length and neck pipe

Option codes



This supplement must be an inseparable part together with the base certificate **LOM 08ATEX2016 X**

This Certificate is a translation from the original in Spanish. The LOM liability applies only on the Spanish text

(This document may only be reproduced in its entirety and without any change)

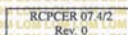

UNIVERSIDAD POLITÉCNICA DE MADRID
ENSAYOS E INVESTIGACIONES DE MATERIALES Y EQUIPOS PARA ATMÓSFERAS EXPLOSIVAS Y MINERÍA
(Real Decreto 334/1992 de 3 de Abril - BOE 1992-04-29)



Alenza, I - 28003 MADRID • ☎ (34) 91 4421366 / 91 3367009 • 📠 (34) 91 4419933 • ✉ lom@lom.upm.es



LABORATORIO OFICIAL J. M. MADARIAGA

(3) Supplement nr. 1 to EC-Type Examination Certificate number LOM 08ATEX2016 X

(8) Variations included in this certificate (continue)

Variants with type of protection Ex td

T L

General code(type)

TWL 6 TTL

Sub-type

Immersion length

Process connection

Type and number of elements

Sensor wiring

Head type

Transmitter type

Options codes

(9) Changes in marking

Only those that correspond to the new type codification

(10) Descriptive documents

Description nr.: DT0387 DT0388

Rev. Date 2009-07-14 2009-07-14



Madrid, 2009-10-21

Carlos Fernández Ramón DIRECTOR OF THE LABORATORY

Angel Vega Remesal Head of ATEX area

RECIBO 0742 Rev 0

(This document may only be reproduced in its entirety and without any change)

14 Note

KOBOLD MESURA S.L.U
Avda. Conflent 68 nave 15
08915 Badalona
Tel.: +34 93 460 38 83
Fax: +34 93 460 38 76
E-Mail: info.es@kobold.com
www.kobold.com

Technical data
Subject to change without prior notice

