



Operating Instruction
for
Electronic Flow Monitor
Compact Version

Model: KAL-K



1. Contents

1. Contents.....	2
2. Note	3
3. Instrument Inspection.....	3
4. Regulation Use	4
5. Operating Principle.....	5
6. Mechanical Connection.....	6
7. Electrical Connection and Operational Elements	6
8. Characteristics	8
9. Output Characteristic (only for 24 V _{DC}).....	9
10. Commissioning.....	10
11. Maintenance	11
12. Technical Information.....	12
13. Order Codes	12
14. Dimensions	12
15. Disposal	13
16. 3A certificate 28-05	14
17. EU Declaration of Conformance	15
18. UK Declaration of Conformity.....	17

Manufactured and sold by:

Kobold Messring GmbH
Nordring 22-24
D-65719 Hofheim
Tel.: +49(0)6192-2990
Fax: +49(0)6192-23398
E-Mail: info.de@kobold.com
Internet: www.kobold.com

2. Note

Please read these operating instructions before unpacking and putting the unit into operation. Follow the instructions precisely as described herein.

The instruction manuals on our website www.kobold.com are always for currently manufactured version of our products. Due to technical changes, the instruction manuals available online may not always correspond to the product version you have purchased. If you need an instruction manual that corresponds to the purchased product version, you can request it from us free of charge by email (info.de@kobold.com) in PDF format, specifying the relevant invoice number and serial number. If you wish, the operating instructions can also be sent to you by post in paper form against an applicable postage fee.

Operating instructions, data sheet, approvals and further information via the QR code on the device or via www.kobold.com

The devices are only to be used, maintained and serviced by persons familiar with these operating instructions and in accordance with local regulations applying to Health & Safety and prevention of accidents.

When used in machines, the measuring unit should be used only when the machines fulfil the EC-machine guidelines 2006/42/EG.

3. Instrument Inspection

Instruments are inspected before shipping and sent out in perfect condition.

Should damage to a device be visible, we recommend a thorough inspection of the delivery packaging. In case of damage, please inform your parcel service / forwarding agent immediately, since they are responsible for damages during transit.

Scope of delivery:

The standard delivery includes:

- Electronic Flow Monitor, Compact Version model: KAL-K

5. Operating Principle

The KAL-K Flow Monitor uses the proven thermal dispersion principle and operates as follows. The probe is heated internally to a few degrees above the temperature of the medium into which it extends. The flowing medium removes this heat from the probe. The cooling rate is proportional to the flow rate. The measured flow rate is compared to the set point value selected by user. If the set point is reached, the electronic circuit activates a transistor switch and bi-coloured alarm LED. The electronic circuit also controls an LED trend indicator which can be used to indicate relative system flow. The microprocessor- controlled design permits sample calibration and set-up. The compact probe design permits monitoring of flow rate with minimal pressure loss.

6. Mechanical Connection

Prior to installation

- Ensure that the actual system flow rate is within the switching range of the KAL-K.
- Ensure that the maximum system temperature and pressure are within the limits specified per section. (see section **Fehler! Verweisquelle konnte nicht gefunden werden.. Fehler! Verweisquelle konnte nicht gefunden werden.**)

Fitting

Mount the sensor into the piping and make sure that it is completely filled with fluid. The probe tip has to reach at least 5 mm (better > 5 mm) into the pipe (see below).

Fitting position

The sensor can be mounted in any orientation as long as the piping is completely filled with fluid. The mounting position has to be smooth and free of turbulence.

(Recommended input and output length: 5 x pipe diameter, of straight - run piping both upstream and downstream of the flow switch). In case of sediments in the pipe the shown mounting position is recommended.

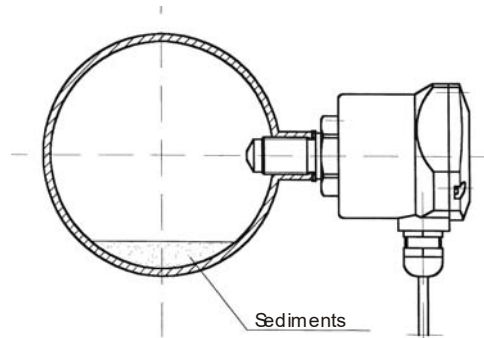

7. Electrical Connection and Operational Elements



Attention! Ensure that the power is disconnected during the connection of the cable.

Ensure that the voltage of your installation corresponds to the voltage values given on the device's specification plate.

24 V_{DC}-Version (terminal connector)

- Remove electronic cover (The fixing screws are secured against falling out)
- Strip 3-wire cable (approx. 40-60 mm), strip single wires (approx. 4-6 mm) and pull through cable gland.

1		Output
2		Ground
3		+24 V _{DC}

- Connect wires to terminal connector block according to the drawing.
- Tighten cable gland.
- After connection, apply supply voltage of 24 VDC \pm 20%. (see **Fehler! Verweisquelle konnte nicht gefunden werden.. Fehler! Verweisquelle konnte nicht gefunden werden.**)
- Check function of electronic (set point LED must flash)
- Calibrate flow switch (see 10. Commissioning)

24 V_{DC}-Version (plug or plug with cable)

- Connect wires to terminal connector block according to drawing below.
- After connection apply supply voltage of 24 VDC \pm 10 %. (see **Fehler! Verweisquelle konnte nicht gefunden werden.. Fehler! Verweisquelle konnte nicht gefunden werden.**)
- Check function of electronic (set point LED must flash)
- Calibrate flow switch (see 10. Commissioning)

View upon the plug

- | | | |
|---|-------|----------|
| 1 | brown | + 24 VDC |
| 2 | white | output |
| 3 | blue | 0 VDC |
| 4 | black | output |

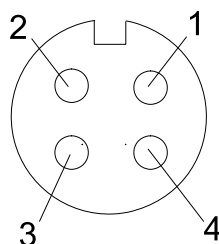

110 V_{DC}, 110 V_{AC} or 230 V_{AC}-version

- Remove electronic cover.
(The fixing screws are secured against falling out)
- The devices are supplied either with coded cables or a plug connection.
- Connect single wires or plug according to drawings below.
- After connection apply supply voltage according to label on the device and technical data (for tolerances see section **Fehler! Verweisquelle konnte nicht gefunden werden.. Fehler! Verweisquelle konnte nicht gefunden werden.**).
- Check function of electronic (set point LED must flash).
- Calibrate Flow Monitor (see 10. Commissioning).

cable

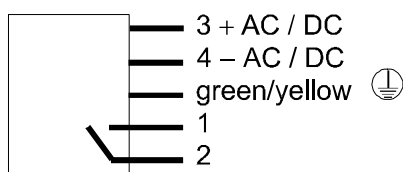

plug

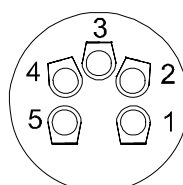

- | | |
|----|-----------|
| 2: | - DC / AC |
| 4: | + DC / AC |
| 3: | PE: |
| 1: | |
| 5: | |

8. Characteristics

LED Trend Indicator (1)

The LED trend indicator (8 LEDs) is used to indicate

- the flow rate (LED, starting left). The adjusted switching point is indicated by a flashing LED.
- If the flow rate has reached the set point value selected by the user, then the LED is flashing faster.

Bi-coloured LED (2)

The bi-coloured LED serves

- to display the switching point.
 - RED = ALARM (flow below the set point)
 - GREEN = (flow above the set point)

The bi-coloured LED is lit all time during this operation mode.

- If a calibration is done the bi-coloured LED flashes green (see also section 10. Commissioning.).
- If any signal error occurs the bi-coloured LED flashes red.

SET pushbutton (3)

The calibration switch (set) is used to start the flow calibration procedure.

Set point Potentiometer (4)

The set point potentiometer is used to adjust the flow set point. You will notice that the flashing LED moves along the trend indicator scale as the set point potentiometer is adjusted.

Output Selector Switch (only for 24 V_{DC}) (5)

The output selector switch is used to select between the output logic NPN and PNP.

(Output selector switch right: NPN-output
Output selector switch left: PNP-output)

KAL-K ...24 V_{DC}

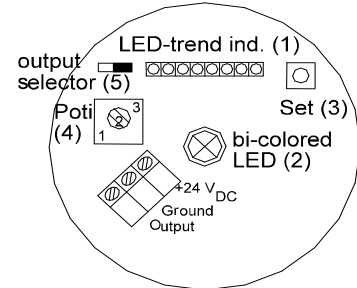

KAL-K..., 110 V_{DC}
110 V_{AC}, 230 V_{AC}

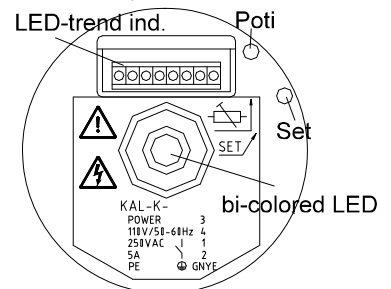

9. Output Characteristic (only for 24 V_{DC})

The output characteristics can be set by the output selector switch.

NPN output:

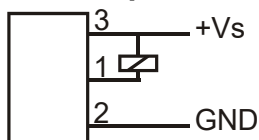

The semiconductor output switches to GND (GROUND = 0 V_{DC}) or is highly resistant. The maximum output current is 400 mA.

The reference point for the NPN-output is +24 V_{DC}.

PNP-output

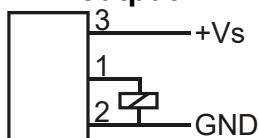

The semiconductor output switches to +24 V_{DC} or is highly resistant. The maximum output current is 400 mA. The reference point for the PNP-output is GND (GROUND = 0 V_{DC}).

Output function

N/O function

In the N/O function the output switches into the low resistance state.

	PNP	NPN	DUO-LED
Actual value > set point			green
Actual value < set point			red
Break down power supply			off

It is recommended to operate with the N/O switch output because in case of system flow being above the flow set point - which means that the N/C switch is de-activated - and the power supply breaks down the output switch will not be able to switch an "ALARM" anymore.

N/C Switch

(Not recommendable for safety reasons)

	PNP	NPN	DUO-LED
Actual value > set point			green
Actual value < set point			red
Break down power supply			off

10. Commissioning

The use of this meter in machines according to directive 2006/42/EG is prohibited until the complete machine complies to this directive.

After mechanical ("Mechanical Connection") and electrical ("Electrical Connection") installation of the sensor the KAL-K has to be put into operation as described in this section.

Calibration

a) Zero flow calibration

- Stop the flow of the liquid in the piping in which the sensor is installed. It is important that the sensor tip be immersed in the liquid. There should be no bubbles around the sensor tip.
- Turn set point adjustment potentiometer counter clockwise to its far left-hand stop and now briefly press the SET button.
- The bi-coloured LED will flash green.
- Do not make any changes (potentiometer setting, etc.) while the bi-coloured LED is blinking. This adjustment phase will last approx. 5-15 sec.
- When the bi-coloured LED stops flashing, the zero flow calibration is set.
- The device now switches automatically to the monitoring mode and displays no flow. The LED strip is not illuminated; only the threshold value LED is flashing.
- The Flow Monitor is ready for operation.

b) Calibration of the trend indicator span

The KAL-K is factory checked and pre-set at its maximum span.

At a lower flow speed, not all 8 LEDs will illuminate. To achieve finer monitoring resolution, the measuring range can be adapted to better fit the actual flow speed.

- Rotate the potentiometer clockwise as far as it will go to the right-hand stop. The extreme right-hand LED in the LED strip will blink. Set the desired maximum flow speed.
- Now press the SET button. The bi-coloured LED blinks green.
- Do not make any changes (potentiometer setting, etc.) while the bi-coloured LED is blinking. This adjustment phase will last approx. 5-15 sec.
- The device now switches automatically to the monitoring mode. This adjustment has set the device measuring range so that it now extends across the entire LED strip to indicate the flow value.
- The adjustment procedure is now complete. It may be repeated as often as necessary.

c) Measuring mode

After adjustment, the flow monitor is once again in measuring mode.

The flow is constantly monitored and the actual value of the flow speed is displayed on the LED strip.

Switching point adjustment

The potentiometer is now used to set the switching point (threshold) of the flow switch. The switching point is displayed as a blinking LED. If the flow rate increases to the point that illuminated LEDs (actual flow value) reaches the position of the blinking LED (set point), the flow monitor switches over from ALARM to FLOW. This can be seen at the display: the bi-coloured LED that was showing a steady red light now switches to a steady green light. The output is also switched at the same time.

slowly flashing switching point-LED (set point)

○ ○ ○ ○ ⊗ ○ ○ ○ ○

⊗ Bi-coloured LED = red

Actual value < set point

Alarm status

Actual value = 0: no flow present

slowly flashing switching point-LED (set point)

⊗ ⊗ ○ ⊗ ○ ○ ○ ○

LED ⊗ Bi-coloured LED = red

Actual value

Actual value < set point

Alarm status

Actual value too low

fast flashing switching point-LED (set point)

⊗ ⊗ ⊗ ⊗ ○ ○ ○ ○

LED ⊗ Bi-coloured LED = green

Actual value

Actual value = set point

Flow status currently being switched

Actual value has just reached set point

slowly flashing switching point-LED

⊗ ⊗ ⊗ ⊗ ⊗ ⊗ ○ ○

LED actual value

⊗ Bi-coloured LED = green

Actual value > set point

Flow status (ideal conditions)

This is the most desirable status.

After the settings are completed, screw the cover tightly back on the housing

11. Maintenance

The unit is virtually maintenance free. Occasional cleaning of the immersed probe may be required if the fluid media is such that it tends to deposit or build.

12. Technical Information

Operating instructions, data sheet, approvals and further information via the QR code on the device or via www.kobold.com

13. Order Codes

Operating instructions, data sheet, approvals and further information via the QR code on the device or via www.kobold.com

14. Dimensions

Operating instructions, data sheet, approvals and further information via the QR code on the device or via www.kobold.com

15. Disposal

Note!

- Avoid environmental damage caused by media-contaminated parts
- Dispose of the device and packaging in an environmentally friendly manner
- Comply with applicable national and international disposal regulations and environmental regulations.

Batteries

Batteries containing pollutants are marked with a sign consisting of a crossed-out garbage can and the chemical symbol (Cd, Hg, Li or Pb) of the heavy metal that is decisive for the classification as containing pollutants:

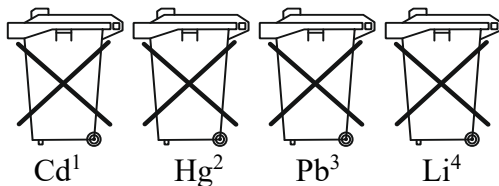

1. „Cd" stands for cadmium
2. „Hg" stands for mercury
3. „Pb" stands for lead
4. „Li" stands for lithium

Electrical and electronic equipment

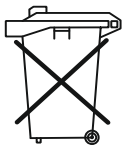

16. 3A certificate 28-05

ISSUE DATE: July 18, 1995

CERTIFICATE AUTHORIZATION NUMBER: 840



THIS IS TO CERTIFY THAT

KOBOLD Instruments
1801 Parkway View Drive, Pittsburgh, PA 15205

is hereby authorized to continue to apply the
3-A Symbol to the models of equipment, conforming to 3-A Sanitary Standards for:

Number 28-05
28-05 (Flow Meters)

set forth below

Clean-in-Place Model Number(s):
Flow Switches: KAL-4340S with options C, P03R, P04R, K, M12, F
Flow Transmitters: KAL-7340S with options C, P, M12

VALID THROUGH: **December 31, 2019**

Timothy R. Rugh
Executive Director
3-A Sanitary Standards, Inc.

The issuance of this authorization for the use of the 3-A Symbol is based upon the voluntary certification, by the applicant for it, that the equipment listed above complies fully with the 3-A Sanitary Standard(s) designated. Legal responsibility for compliance is solely that of the holder of this Certificate of Authorization, and 3-A Sanitary Standards, Inc. does not warrant that the holder of an authorization at all times complies with the provisions of the said 3-A Sanitary Standards. This in no way affects the responsibility of 3-A Sanitary Standards, Inc. to take appropriate action in such cases in which evidence of nonconformance has been established.

NEXT TPV INSPECTION/REPORT DUE: **December 2023**

17. EU Declaration of Conformance

We, KOBOLD Messring GmbH, Nordring 22-24, 65719 Hofheim, Germany, declare under our sole responsibility that the product:

Electronic Flow Monitor model: KAL-K

to which this declaration relates is in conformity with the following EU directives stated below:

2011/65/EU **RoHS** (category 9)
2015/863/EU Delegated Directive (RoHS III)

Additionally for electronic option with **24 V_{DC}**:

2014/30/EU **EMC Directive**

Additionally for electronic option with **110 V_{AC}**, **110 V_{DC}**, **230 V_{AC}**:

2014/30/EU **EMC Directive**
2014/35/EU **Low Voltage Directive**

Also, the following standards are fulfilled:

EN IEC 63000:2018 Technical documentation for the assessment of electrical and electronic products with respect to the restriction of hazardous substances

Additionally for electronic option with **24 V_{DC}**:

EN IEC 61326-1:2021 Electrical equipment for measurement, control and laboratory use - EMC requirements - Part 1: General requirements, Industrial area, (measurement of immunity to HF field up to 1 GHz)

Additionally for electronic option with **110 V_{AC}**, **110 V_{DC}**, **230 V_{AC}**:

EN 61010-1:2010 + A1:2019 + A1:2019/AC:2019 Safety requirements for electrical equipment for measurement, control and laboratory use - Part 1: General requirements

EN IEC 61000-6-4:2019 Electromagnetic compatibility (EMC) - Part 6-4: Generic standards - Emission standard for industrial environments, Interference emission industry

EN 61000-4-4:2013 Electromagnetic compatibility (EMC) - Part 4-4: Testing and measurement techniques - Electrical fast transient/burst immunity test, BURST 2 kV

EN 61000-4-6:2014 Electromagnetic compatibility (EMC) - Part 4-6: Testing and measurement techniques - Immunity to conducted disturbances, induced by radio-frequency fields, HF coupling 10 V

EN IEC 61000-4-3:2021 Electromagnetic compatibility (EMC) - Part 4-3: Testing and measurement techniques - Radiated, radio-frequency, electromagnetic field immunity test, HF irradiation 10 V/m

EN 61000-4-2:2009 Electromagnetic compatibility (EMC) - Part 4-2: Testing and measurement techniques - Electrostatic discharge immunity test, ESD 4/8 kV

Hofheim, 03 Jan 2024



H. Volz
General Manager



J. Burke
Compliance Manager

18. UK Declaration of Conformity

We, KOBOLD Messring GmbH, Hofheim-Ts, Germany, declare under our sole responsibility that the product:

Electronic Flow Monitor model: KAL-K

to which this declaration relates is in conformity with the following UK directives stated below:

S.I. 2012/3032 The Restriction of the Use of Certain Hazardous Substances in Electrical and Electronic Equipment Regulations 2012

Additionally for electronic option with **24 V_{DC}**:

S.I. 2016/1091 Electromagnetic Compatibility Regulations 2016

Additionally for electronic option with **110 V_{AC}, 110 V_{DC}, 230 V_{AC}**:

S.I. 2016/1091 Electromagnetic Compatibility Regulations 2016

S.I. 2016/1101 Electrical Equipment (Safety) Regulations 2016

Also, the following standards are fulfilled:

BS EN IEC 63000:2018

Technical documentation for the assessment of electrical and electronic products with respect to the restriction of hazardous substances.

Additionally for electronic option with **24 V_{DC}**:

BS EN IEC 61326-1:2021, Electrical equipment for measurement, control and laboratory use. EMC requirements. General requirements, Industrial area, (measurement of immunity to HF field up to 1 GHz)

Additionally for electronic option with **110 V_{AC}, 110 V_{DC}, 230 V_{AC}**:

BS EN 61010-1:2010+A1:2019

Safety requirements for electrical equipment for measurement, control, and laboratory use. General requirements

BS EN IEC 61000-6-4:2019 Electromagnetic compatibility (EMC). Generic standards. Emission standard for industrial environments

BS EN 61000-4-4:2012 Elektromagnetische Verträglichkeit (EMV) - Teil 4-4: Prüf- und Messverfahren - Prüfung der Störfestigkeit gegen schnelle transiente elektrische Störgrößen/Burst, BURST 2 kV

BS EN 61000-4-6:2014 Electromagnetic compatibility (EMC). Testing and measurement techniques. Immunity to conducted disturbances, induced by radio-frequency fields, HF coupling 10 V

BS EN IEC 61000-4-3:2020 Electromagnetic compatibility (EMC). Testing and measurement techniques. Radiated, radio-frequency, electromagnetic field immunity test, HF irradiation 10 V/m

BS EN 61000-4-2:2009 Electromagnetic compatibility (EMC). Testing and measurement techniques. Electrostatic discharge immunity test, ESD 4/8 kV

Hofheim, 03 Jan. 2024



H. Volz
General Manager



J. Burke
Compliance Manager