



**Operating Instruction  
Supplement  
for  
Compact Electronics**

**Model:..C30R;..C30M  
..C34P;..C34N**



## 1. Contents

---

1. Contents.....	2
2. Note .....	3
3. Electrical Connection .....	4
4. Programming .....	5
5. Maintenance .....	12
6. Technical Information.....	13
7. Disposal .....	14

**Manufactured and sold by:**

Kobold Messring GmbH  
Nordring 22-24  
D-65719 Hofheim  
Tel.: +49(0)6192-2990  
Fax: +49(0)6192-23398  
E-Mail: [info.de@kobold.com](mailto:info.de@kobold.com)  
Internet: [www.kobold.com](http://www.kobold.com)

## 2. Note

---

**This programming instruction is only a supplement to the operating instruction for the sensor.**

---

The instruction manuals on our website [www.kobold.com](http://www.kobold.com) are always for currently manufactured version of our products. Due to technical changes, the instruction manuals available online may not always correspond to the product version you have purchased. If you need an instruction manual that corresponds to the purchased product version, you can request it from us free of charge by email ([info.de@kobold.com](mailto:info.de@kobold.com)) in PDF format, specifying the relevant invoice number and serial number. If you wish, the operating instructions can also be sent to you by post in paper form against an applicable postage fee.

### 3. Electrical Connection

---

#### 3.1. General



**Attention! Make sure that the voltages in your plant correspond with the instrument voltages**

- Make sure that the supply wires are de-energized.
- Connect the supply voltage and evaluation of both output signals to the plug connector PINs as shown in section 3.2 and 3.3.
- We recommend the use of wires with cross sectional area of min. 0,25 mm<sup>2</sup>



**Attention! Incorrect wiring will lead to damage of the unit's electronics.**

#### 3.2. Compact Electronics: (..C30R, ..C30M)

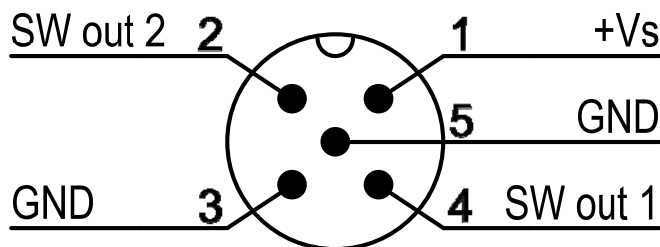

#### 3.3. Compact Electronics: (..C34P, ..C34N)

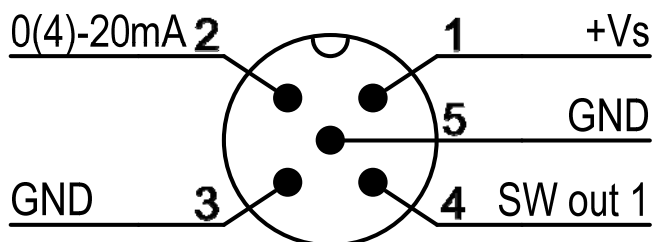

Terminals 3 and 5 are linked internally and can therefore be used either for the output signal or the power supply.

## 4. Programming

Connect the compact electronics according to the previous wiring diagram and apply the specified voltage.

The measuring range (upper range value) is displayed for 3 seconds after switch-on.

### 4.1. Key Function

Standard mode (measuring mode)

 : pressing 3 sec. → set-up mode

 : switchpoint/window point

Set-up mode

 : Next level

 : Set value

Anytime:  
3 sec   
or 20 sec  
no key pressing  
↓  
Standard mode

### 4.2. Settings

The following values can be changed in the compact electronics:

	Scale range	Factory setting
Switching point (SPo, SP1, SP2)	0 - 999	0.00
Hysteresis (HYS)	-199 - 0	-0.00
Window point (duo)	Switching point ...999	--- (de-activated)
Filter (Filt)	1/2/4/8/16/32/64	1
Contact type (Con, Co1, Co2)	N/O contact (no), N/C (nc) or frequency (Fr)**	no (N/O contact)
Start current (S-C)*	000 - 999	000
End current (E-C)*	000 - 999	Upper range value
Start current selection (SCS)	0-- (0 mA), 4-- (4 mA)	4 mA
Change code (CCo)	000 - 999	000

\* Lower and upper range values of the flow rate are based on 0/4-20 mA.

\*\* only for sensors with impulse output (e.g. DPE)

### 4.3. Value Setting

You can select Value setting in the main menu item (for example: Switching point, "SPo") by pressing the "◆" key. The structure shown below illustrates the universal routine for changing individual parameters.

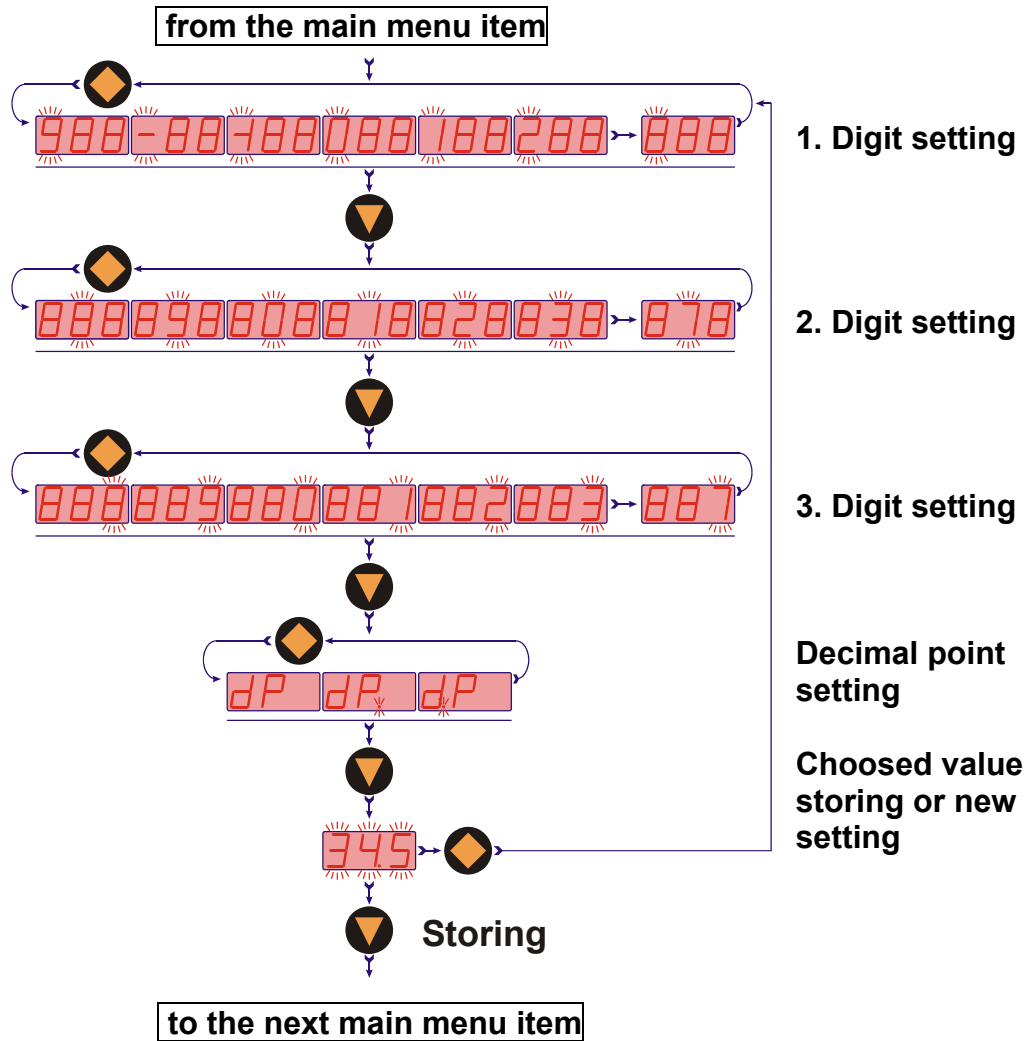

### 4.4. Set-up Mode

#### Compact electronics ...C30..

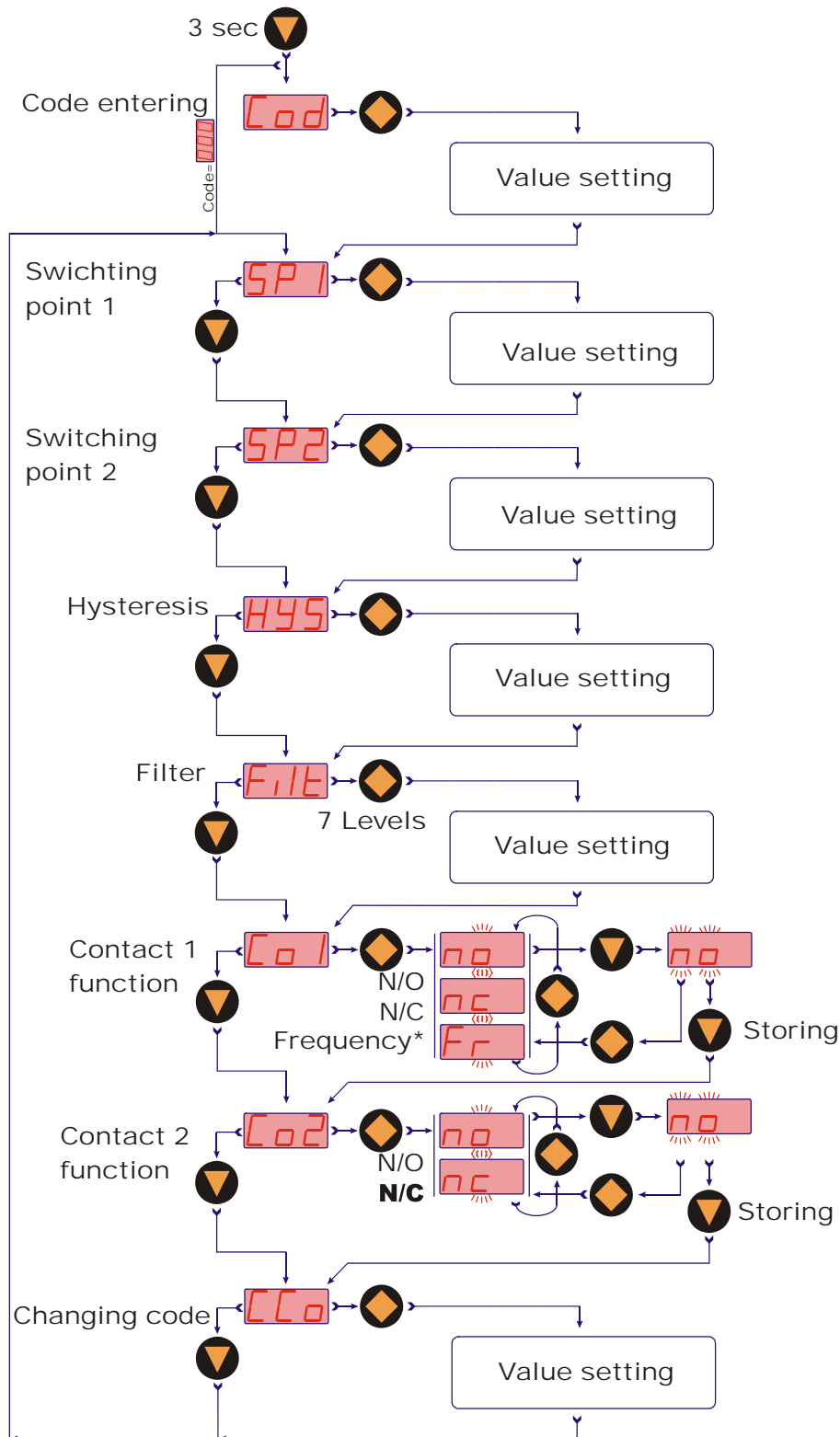

\*Only for sensors with impulse output

# Compact electronics ...C34..

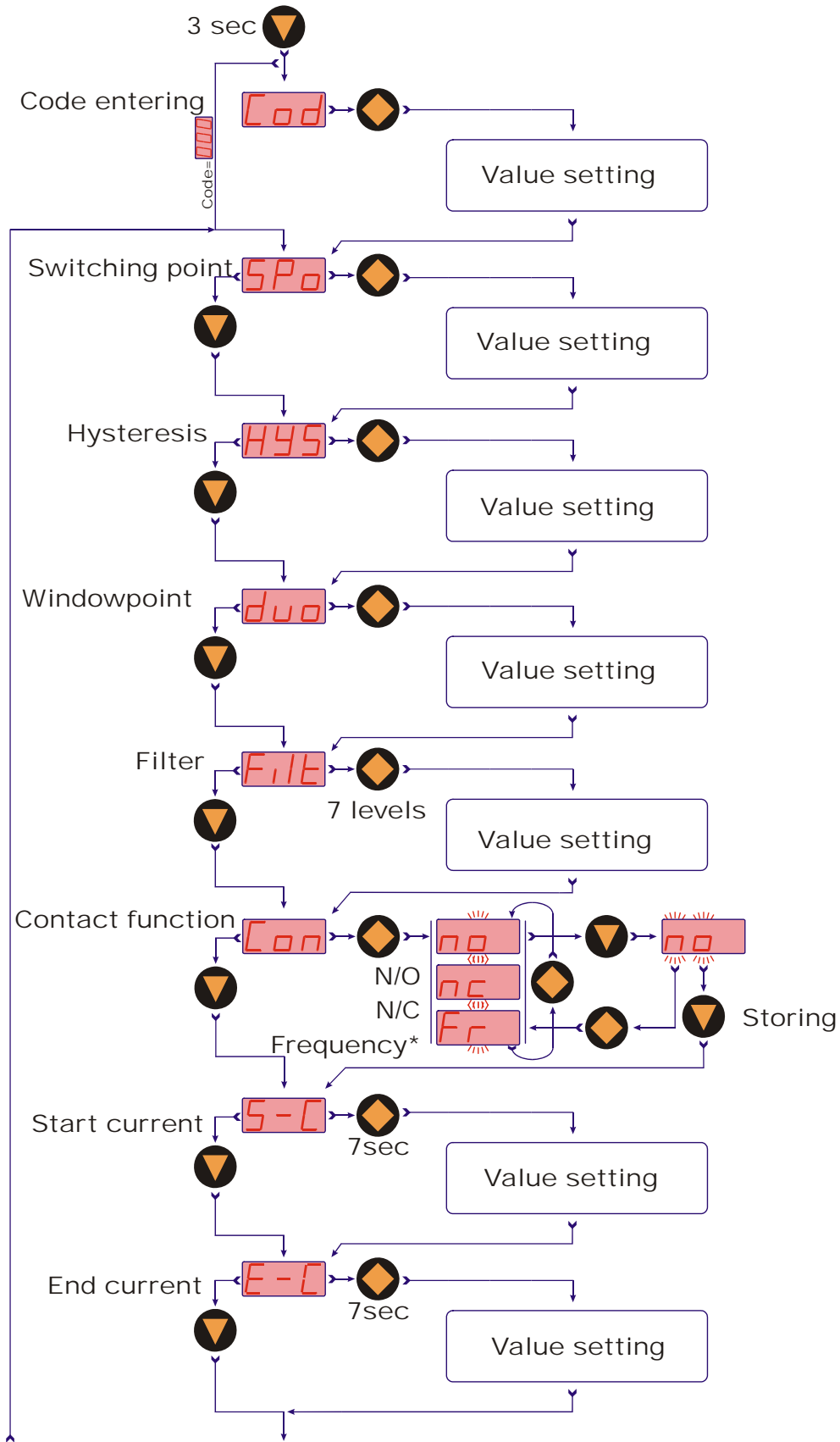

\*Only for sensors with impulse output



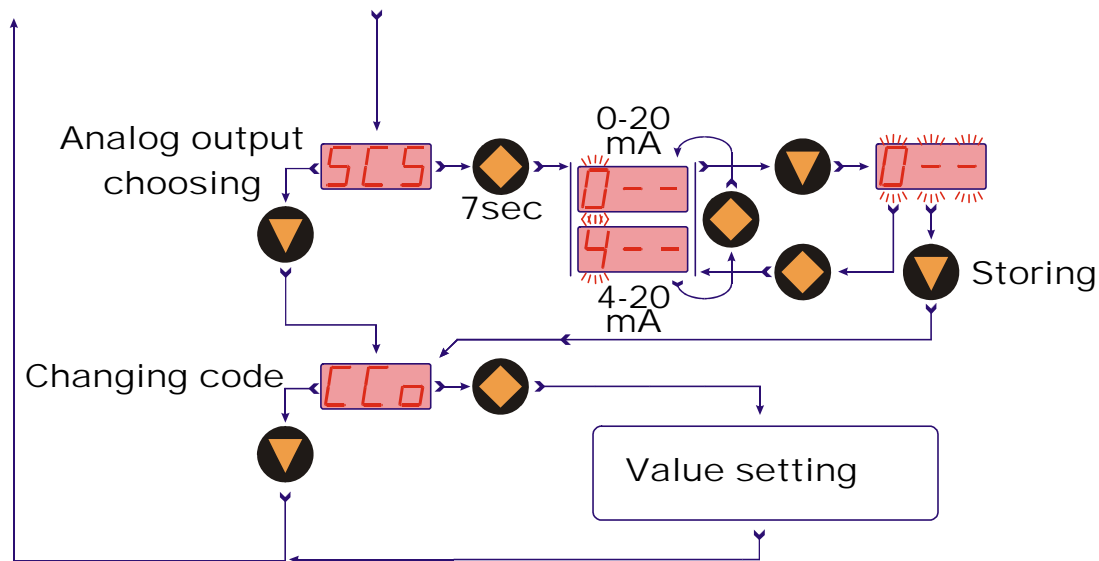

## 4.5. Main Menu Items

### Switching point

The switching point is entered in menu item "**SP0, SP1, SP2**". A value in the range 000 to 999 may be chosen. A decimal point position is also assigned to this value. The position of the decimal point can be set after the first, second or last position (no decimal point). If the indicated value exceeds the set switching point, then the electronics switches and energizes the LED.

If the hysteresis is equal to zero and the window point is de-activated, the electronic switches back whenever the indicated value falls below the switching point.

### Hysteresis

After the switching point, hysteresis can be entered as a negative value in the menu "**HYS**". The default hysteresis value is zero. However this can lead to confused switching, when the measuring signal fluctuates around the switching point or window point. This problem can be cured by increasing the hysteresis. The hysteresis is based on the switching point and the window point (switching point minus hysteresis; window point plus hysteresis).

Example: switching point 100 l/min; hysteresis: -2.5 l/min

The electronics switches when 100 l/min is exceeded and switches back when the flow rate falls below 97.5 l/min.

### Window point (duo point)

A window point "**duo**" (duo point) can be defined in addition to the switching point. The window point must be greater than the switching point. The measured value can be monitored within a set range by means of the window point and switching point. The switching point marks the lower end of the range of values and the window point the upper end.

If the window point (duo point) is lower than or equal to the switching point, an error message is displayed (Er4), its value is then deleted and thus its function is disabled (applies to window point and switching point setting).

Value setting is similar to switching point setting.

The window point serves to monitor the measured value within a set range.

**Example:** Switching point: 100 l/min; window point: 150 l/min; hysteresis: -1 l/min  
The electronics switches when 100 l/min is exceeded. When the measured value stays within the limits 99 l/min (100-1) and 151 l/min (150+1), then the electronics also remains in the activated switch state (LED on). Should the measured value exceed 151 l/min or drop below 99 l/min, then the electronics switches back.

### Switching performance

The switching performance of the electronics is illustrated in the diagram below. The contact closes (N/O contact) when the switching point is exceeded or when the value drops below the window point. It opens when the window point plus hysteresis is exceeded or when the value drops below the switching point minus hysteresis. The switch state of the electronics is indicated by an **LED**.

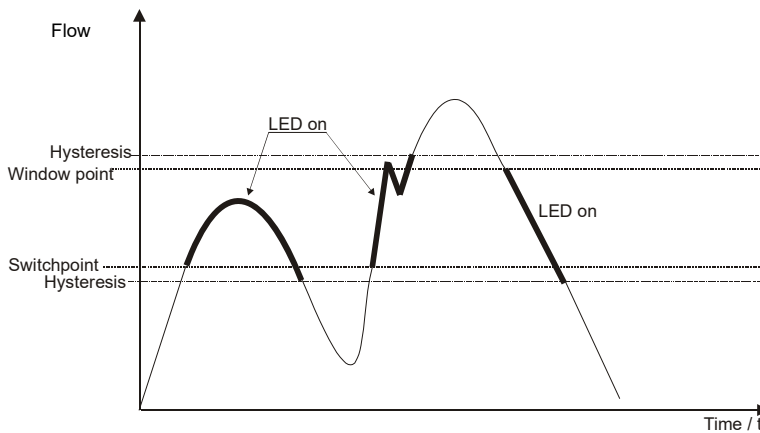
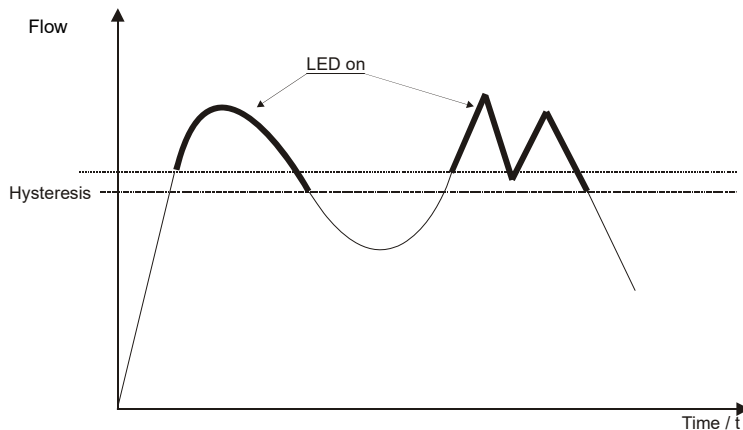

**Filter**

The filter function "**Filt**" generates the sliding average value from the measured values. The following values are available (see section 6.2 Settings):

1 / 2 / 4 / 8 / 16 / 32 / 64

The filter value determines the dynamic behaviour of the indicated value: high values result in a slow display response. The filter is disabled if a filter value of "1" is selected. In other words, the indicated value is equal to the unfiltered measured value.

The integrated step detector responds to a measured-value step change greater than approximately 6.25% of the upper range value. When a measured-value step change is detected, the actual measured value is displayed immediately.

**Contact Model**

The function of the transistor switching output is set in menu item "**Con, Co1 or Co2**". The switching function switches from

**no - N/O contact to**

**nc - N/C to**

**Fr – frequency** (Con and Co1 only and for sensors with impulse output)

and back.

N/O contact means: contact closes when switching point is exceeded

N/C means: contact opens when switching point is exceeded

Frequency means: frequency output synchronized with vane frequency

**Current output**

The current output is selected in menu items

**"S-C"** Start current indicated value  $< > 0(4)$  mA

**"E-C"** End current indicated value  $< > 20$  mA

**"SCS"** Start current selection (0-20 mA or 4-20 mA).

The indicated value at which 0(4) mA flow is entered in menu item Start current.

The indicated value at which 20 mA flow is entered in menu item End current.

**Change Code**

The change code option "**CCo**" secures the unit against unauthorised tempering. If the code is different from 000, the user must input the code immediately after entering the adjustment mode.

## 5. Maintenance

---

Work on the electronics should only be carried out by the supplier, otherwise the guarantee is nullified.

---

## 6. Technical Information

---

Display:	3-segment LED
Display case:	stainless steel
Analogue output:	(0)4 - 20 mA scalable (...C34 only)
Transistor output:	1 (2) semiconductor PNP or NPN, set at the factory.
Frequency output:	1 transistor output vane frequency (see sensor)
Max. switching current:	300 mA
Function:	N/C / N/O contact programmable with 2 buttons
Setting:	
Supply:	24 V <sub>DC</sub> ±20%, 3-wire technology
Electrical connection:	plug connector M12x1

## 7. Disposal

---

### Note!

- Avoid environmental damage caused by media-contaminated parts
- Dispose of the device and packaging in an environmentally friendly manner
- Comply with applicable national and international disposal regulations and environmental regulations.

### Batteries

Batteries containing pollutants are marked with a sign consisting of a crossed-out garbage can and the chemical symbol (Cd, Hg, Li or Pb) of the heavy metal that is decisive for the classification as containing pollutants:

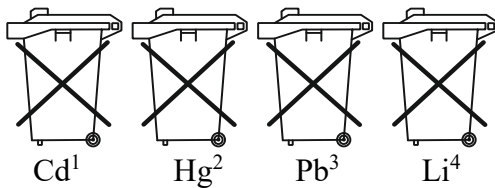

1. „Cd" stands for cadmium
2. „Hg" stands for mercury
3. „Pb" stands for lead
4. „Li" stands for lithium

### Electrical and electronic equipment

