



# Non-Contact Radar Level Transmitter



measuring  
•  
monitoring  
•  
analysing

## NRM



Compact version



High temperature version



Stainless steel housing



Parabolic antenna



- Measuring range: up to 23 m
- Accuracy:  $\pm 3$  mm
- $p_{max}$ : 25 bar;  $t_{max}$ : 180 °C
- Process connection: BSP, NPT, pipe coupling, Tri-Clamp®, flange
- Material: PP, aluminium, stainless steel
- Output: 4-20 mA HART®
- Approval: ATEX, IECEx (Ex ia)



Integrated version



N2

KOBOLD companies worldwide:

AUSTRALIA, AUSTRIA, BELGIUM, BULGARIA, CANADA, CHINA, CZECHIA, FRANCE, GERMANY, GREAT BRITAIN, HUNGARY, INDIA, INDONESIA, ITALY, MALAYSIA, MEXICO, NETHERLANDS, PERU, POLAND, REPUBLIC OF KOREA, SPAIN, SWITZERLAND, THAILAND, TUNISIA, TURKEY, USA, VIETNAM

KOBOLD Messring GmbH  
Nordring 22-24  
D-65719 Hofheim/Ts.  
Head Office:  
+49(0)6192 299-0  
+49(0)6192 23398  
info.de@kobold.com  
www.kobold.com

**Description**

The 2-wire non-contact microwave level transmitters type NRM provide the most advanced, new generation measurement technique of the industrial process automation field, available as NRM-4 (compact version) and NRM-7 (integrated version).

**Operation Principle**

The reflection of the emitted microwave impulses is considerably depending on the relative dielectric constant of the measured medium. The essential condition of microwave level measurement is that the relative dielectric constant ( $\epsilon_r$ ) of the medium should be more than 1.9. The operation of the non-contact microwave level transmitters is based on the measurement of the time of flight of the reflected signals, so-called Time Domain Reflectometry (TDR) method. The propagation speed of microwave impulses is practically the same in air, gases and in vacuum, independently from the process temperature and pressure, so the measured distance is not affected by the physical parameters of medium to be measured.

The NRM level transmitter is a Pulse Burst Radar operating at 25 GHz (K-band) microwave frequency. The 25 GHz models' most noticeable advantage over the lower frequency (5-12 GHz) radars are the smaller antenna size, the better focusing, lower dead zone and smaller transmission angle. The level transmitter induces few nanosecond length microwave impulses in the antenna and a part of the energy of the emitted signals reflects back from the measurement surface depending on the measured media. The time of flight of the reflected signal is measured and processed by the electronics, and then this is converted to distance, level or volume proportional data.

**Areas of Applications**

NRM is able to provide an excellent non-contact measurement solution with millimeter precision and excellent measuring stability for liquids, slurries, emulsions and other media for a wide range of application:

- Food industry
- Power industry
- Water industry
- Pharmaceutical industry
- Chemical industry
- Marine applications
- Measurement of media tending to
  - vaporise
  - have layer of gas or fog on surface
- Vacuum application

The NRM is generally only used with liquid media. If the medium contains solid components, this can lead to delayed measurement results. This also applies to extreme wave movements in the medium.

**Basic Concepts of Microwave Level Measurement**

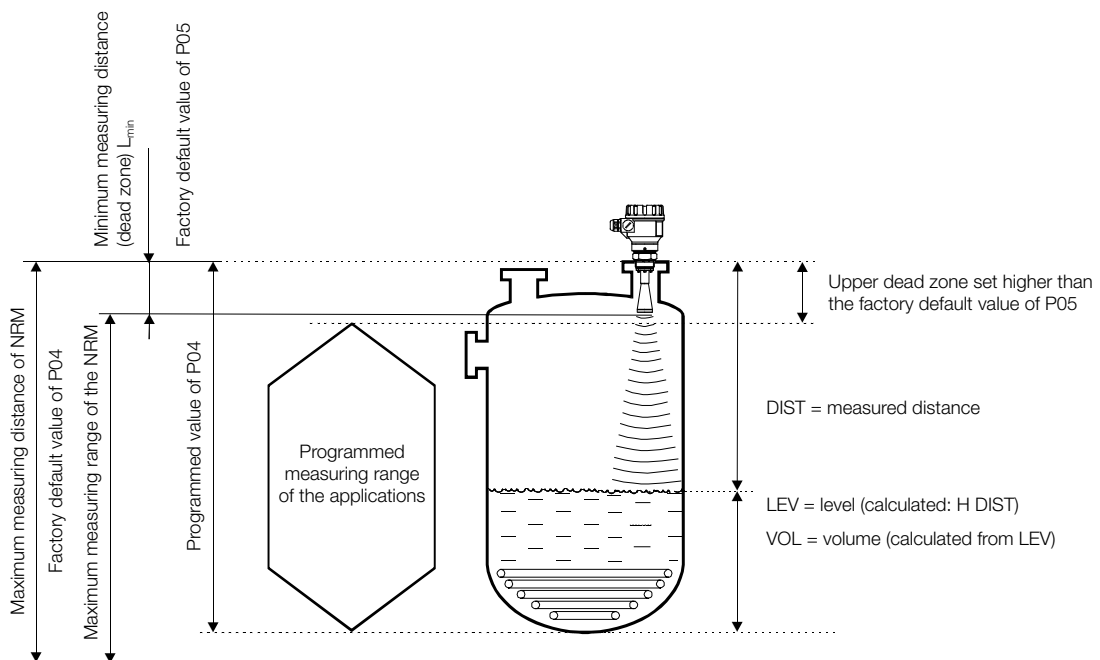



**Technical Details**

Type	Integrated (NRM-7)	Compact (NRM-4)		
		Plastic housing	Metal housing	High temperature version
Measured values	level, distance, volume, mass			
Frequency of measurement signal	~25 GHz (K-band)			
Measuring range	0.2-23 m see »Measuring ranges« page 4			
Linearity error*	<0.5 m: ±25 mm, 0.5-1m: ±15 mm, 1–1.5 m: ±10 mm, 1.5–8 m: ±3 mm, >8 m: ±0.04% of the measured distance			
Min. beam angle	11° depending on the antenna type	6° depending on the antenna type		
Min. εr of the medium	1.9 depending on the meas. range	1.4 depending on the meas. range, see »Measuring ranges« page 4		
Resolution	1 mm			
Temperature error (accord. to EN 61298-3)	0.05% FSK / 10 °C (-20 ... +60 °C)			
Power supply	20 ... 36 V <sub>DC</sub> , ATEX: 20 ... 30 V <sub>DC</sub>			
Output	Digital communication	4-20 mA + HART®		
	Display	NRM-300P graphical display unit (optional)		
Measuring frequency	10 ... 60 s as per application settings			
Antenna diameter	48 mm, 75 mm, 148 mm			
Antenna material	antenna (horn, parabolic): stainless steel 1.4571 (316 Ti); enclosure: PP, PTFE		antenna (horn, parabolic): stainless steel 1.4571 (316 Ti); enclosure: PTFE	
Process temperature	-30 ... +100°C (up to max. 2 min.: 120°C); with PP antenna enclosure: max.: 80°C		-30 ... +180°C	
Maximal medium pressure	25 bar (at 120°C), with plastic antenna enclosure or plastic flange: 3 bar (at 25°C)			
Ambient temperature	-20 ... +60°C			
Process connection	thread, flange, Tri-Clamp®, sanitary connection			
Protection	IP 68/Ex: IP 67		IP 67	
Electrical connection	LiCY cable 2x0.5 mm <sup>2</sup> (AWG20) shielded Ø 6 mm standard cable length 5 m (max. 30 m)		2xM20x1.5 cable glands + internal thread for 2x ½" NPT cable protective pipe, cable outer diameter Ø 7 - 13 mm, wire cross section: max. 1.5 mm <sup>2</sup>	
Housing material	PP	PBT	paint coated aluminium or stainless steel	
Sealing	FKM, EPDM			
Communication certifications	R&TTE, FCC			
Weight	1 - 1.6 kg		aluminium 2-2.6 kg stainless steel 3.3-3.9 kg	aluminium 2.7-3.3 kg stainless steel 4-4.6 kg

\* Under reference conditions: Examined in case of proper application settings at 95% sample rate level. The environment should be free of EMC noises and power supply voltage fluctuations in accordance to the standard, under constant temperature. The reflector should be a plane plate reflector with ideal material, surface and dimensions (min. 3 x 3 m). The largest false echo should be 20 dB smaller than the useful echo.

**Explosion Protection, Ex Markings, Ex-MIN/MAX-Data**

Type	Plastic housing compact	Metal housing	High temperature version with metal housing
IECEx (ia)	Ex ia IIB T6 ... T5 Ga/Gb Li: 200 µH, Ci: 16 nF, Ui: 30 V, Ii: 140 mA, Pi: 1 W	Ex ia IIB T6 ... T4 Ga Li: 200 µH, Ci: 16 nF, Ui: 30 V, Ii: 140 mA, Pi: 1 W	Ex ia IIB T6 ... T3 Ga Li: 200 µH, Ci: 16 nF, Ui: 30 V, Ii: 140 mA, Pi: 1 W
ATEX (ia)	⊕ II 1/2 G Ex ia IIB T6 ... T5 Ga/Gb Li: 200 µH, Ci: 16 nF, Ui: 30 V, Ii: 140 mA, Pi: 1 W	⊕ II 1G Ex ia IIB T6 ... T4 Ga Li: 200 µH, Ci: 16 nF, Ui: 30 V, Ii: 140 mA, Pi: 1 W	⊕ II 1G Ex ia IIB T6 ... T3 Ga Li: 200 µH, Ci: 16 nF, Ui: 30 V, Ii: 140 mA, Pi: 1 W

**Process Connection**

Antenna type	Antenna diameter		
	DN50 (2")	DN80 (3")	DN150 (6")
	Process connection		
	2" BSP/NPT	DN80... DN150 flanges	
Stainless steel (1.4571) horn	x	x	
PP enclosure	x		
PTFE enclosure	x		
Stainless steel (1.4571) parabolic			x

**Beam Angle/Dead Zone**

Antenna	Beam angle	Dead zone [mm]
DN40	19°	200
DN40, encapsulated	25°-27°	300
DN50	16°	200
DN50, encapsulated	25°-27°	300
DN80	11°	200
DN150	6°	400

**Measuring Ranges**

The maximal measuring range of the NRM radars is significantly depending on the circumstances of the application environment and on the selected device type. Depending on the relative dielectric constant  $\epsilon_r$  of the measuring medium and the process conditions the maximal measurement range (achievable under the reference conditions) may decrease by even 85% (reduce about to one-sixth!).

The maximal measuring distance is illustrated in the diagram below in case of materials with different relative dielectric constant. The diagram is valid for horn antenna without plastic enclosure, for liquids with still surface not tending to foaming, vapouring or steaming and in case of ideally slow (<5 m/h) rate of level change.

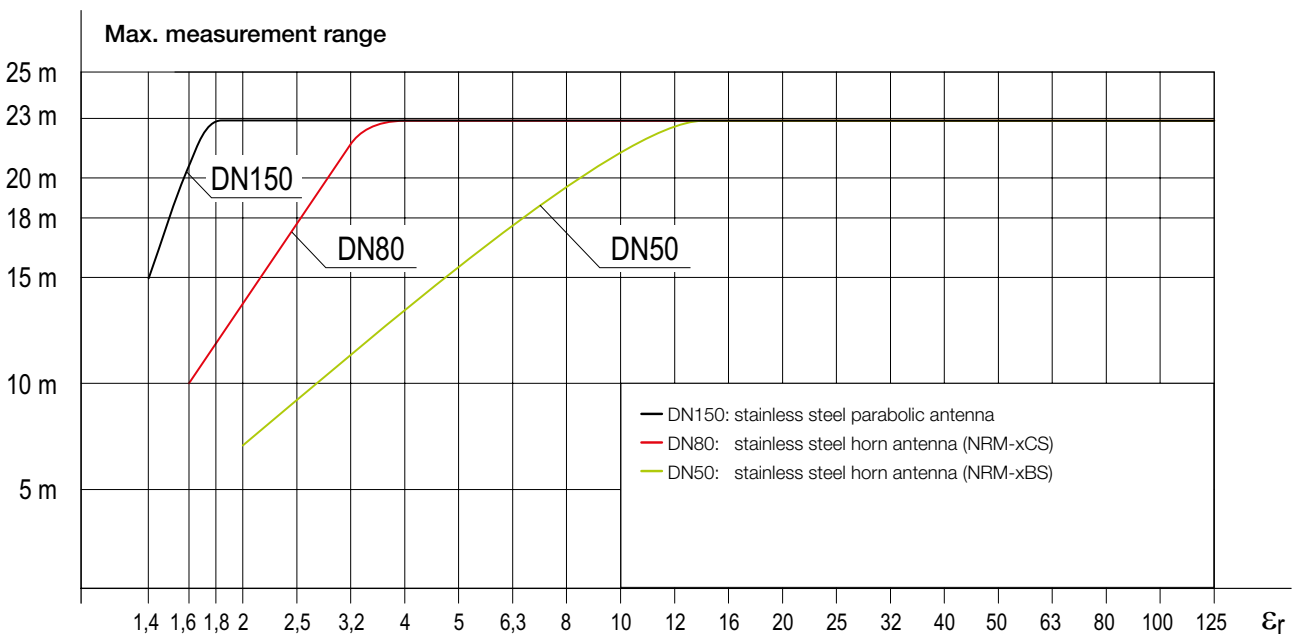



Depending on the process conditions or the plastic antenna enclosure the following typical reducing factors are recommended to be considered in order to calculate the maximal measuring range. When more than one reducing factors occur at the same time then all the factors should be considered for the calculation:

Process condition	Reflection reduction in amplitude	Max. measuring distance by	Reducing factor
Slow mixing or slightly waving	2...6 dB	20 - 50%	0.8 ... 0.5
Foaming	2...6 dB	60 - 70%	0.8 ... 0.5
Fast mixing, vortex	8...10 dB	30 - 70%	0.4 ... 0.3
Steaming, condensation	3...10 dB	20 - 50%	0.7 ... 0.3
PP antenna enclosure	2 dB	20%	0.8
PTFE antenna enclosure	1 dB	10%	0.9

For example: measurement medium is styrene ( $\epsilon_r = 2.4$ ) at 25°C process temperature and slowly mixed. The device type is NRM-4BSR9T100 with PTFE antenna enclosure. The maximal measuring range is:

$$(9 \text{ m} \times 0.5 \times 0.9) = 4 \text{ m}$$

#### Informative $\epsilon_r$ Values

Petroleum	2.1	Acetone	21
Crude oil	2.1	Ethyl alcohol	24
Diesel oil	2.1	Ethanol	25.1
Benzene	2.1	Methyl alcohol	33.1
Gasoline	2.3	Methanol	33.7
Bitumen	2.6	Glycol	37
Carbon disulfide	2.6	Nitrobenzene	40
Ethers	4.4	Glycerol	41.1
Acetic acids	6.2	Water	80
Ammonia	17...26	Sulphuric acid (T = 20 °C)	84

**Electrical Connection**

The instrument operates from 20 ... 36 V galvanic isolated and not grounded DC power supply in two-wire system. (For Ex version: 20 ... 30 V<sub>DC</sub>!)

The voltage value measured on the terminal of the instrument should be minimum 20 V (in case of 4 mA)! In case of using HART® interface The voltage value measured on the terminal of the instrument should be minimum 20 V (in case of 4 mA)! In case of using 250 Ω resistance should be maintained within the network. The instrument should be wired with shielded cable led through the cable gland. The wiring of the cables can be done after removing the cover of the instrument and the NRM-300P display unit.

**Important:** The grounding screw (GND) on the housing of the transmitter should be connected to the equipotential network (EP).

Resistance of the EP network should be  $R \leq 2 \Omega$  measured from the neutral point.

Shielding of the cable should be grounded at the control room side to the EP network. To avoid disturbing noises, keep away of closeness to high-voltage cables. Especially the inductive couplings of AC harmonics can be critical (which are present at frequency converter control) because even cable shielding does not supply effective protection against these cases.

**Wiring diagram compact version (NRM-4)**

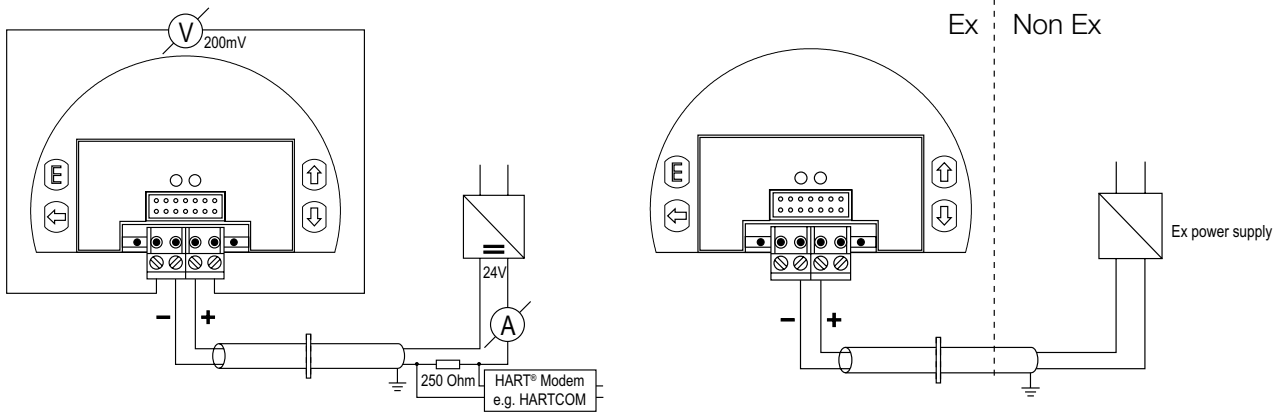

Using HART® communication, in non-Ex environment

Using EX approved instrument in hazardous environment

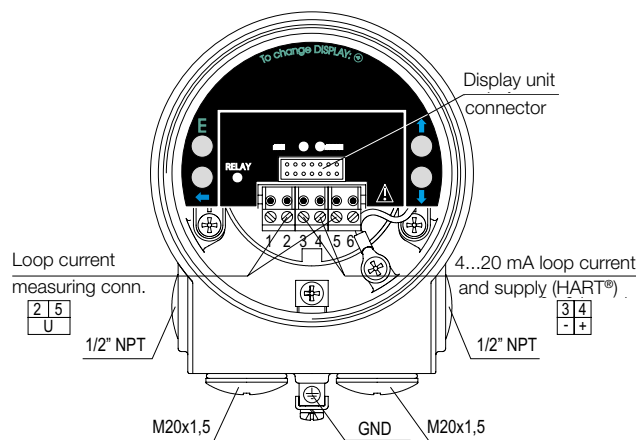

**Wiring diagram integrated version (NRM-7)**

Prior to wiring ensure that the power supply is turned off at the source. (For wiring the unit 6x0,5 mm<sup>2</sup> cross section or greater cable is recommended).

The necessary programming can be made after energising the unit.

**Colour codes**

Green	-	(+) Positive point of current loop measurement
Yellow	-	(-) Negative point of current loop measurement
White	- I	(-) Negative point of current loop, power supply and HART®
Brown	- I	(+) Positive point of current loop, power supply and HART®
Green/Yellow	- GND	Grounding and shielding point

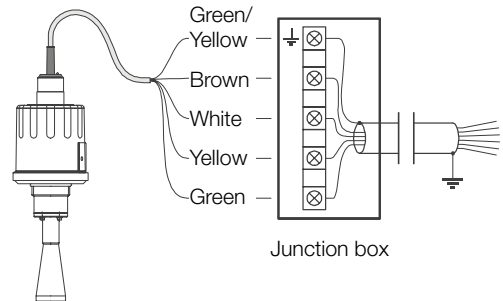

**Extension of the integrated cable**

The usage of a junction box is recommended for extending the cable.

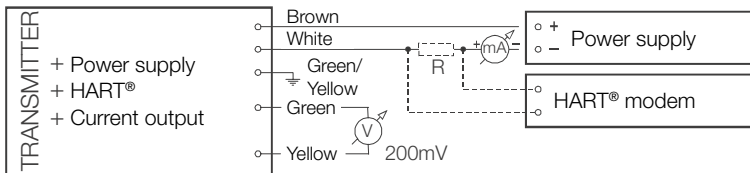

**Display NRM-300P**

The NRM-300P is a 64x128 dot-matrix LCD display which can be plugged into the transmitter (only available for NRM-4).

**Warning!** The NRM-300P module is based on LCD technology, so please make sure it is not exposed to permanent heat or direct sunlight, in order to avoid damage of the display unit. If the instrument cannot be protected against direct sunlight or high temperature that is beyond the standard operating temperature range of the NRM-300P, please do not leave the NRM-300P display in the instrument.

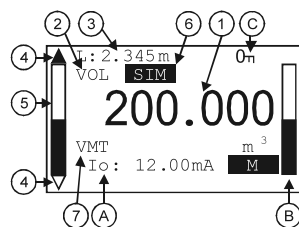

Measurement displaying with the NRM-300P display unit

**Elements of the displaying:**

1. Primary (Measured) Value (PV), in accordance to BASIC SETUP/PV. MODE.
2. Calculation mode of Primary Value (PV), in accordance to BASIC SETUP/PV. MODE.

3. Type and value of the initial quantity used for calculating the Primary Value (PV):
  - in case of Level measurement (LEV) it is Distance (DIST),
  - in case of Volume measurement (VOL) it is Level (LEV).
4. Trend direction arrows. The empty triangle shows when the change of the measured value is small, the filled triangle shows large-scale change. If none of the arrows are shown the measured value is constant.
5. Measured PV (Distance Value) in relation to measurement range (Sensor range) displayed in a bargraph.
6. Indication of Primary Value simulation. In this case the display and output show the values of the simulation and not the measured values.
7. Indication of active (Volume/Mass Table - VMT) calculation mode.

During active simulation the critical measurement errors will be displayed to give information to the user.

**NRM in systems with PC**

Using a PC and HART® modem (e.g. model HARTCOM), it is possible to create your own multi-drop HART® network, where the PC displays all measurement data and also allows reprogramming of the units as necessary. In this way the outputs derived from the displayed data can be programmed via the PC, which acts as the master. A maximum of 15 transmitters can be connected to one HART® modem and KOBOLD's software NUS-NTB-NRM-SW can be used for configuration.



Order Details Compact Version (Example: NRM-4 A P R80 00 0)

Model	Antenna/ measuring range	Material antenna/ housing	Process connection	Output/version/ approval	Options
NRM-4	B = horn-antenna DN50, 2" / (0,2...23 m)	P <sup>2)</sup> 4) = PP/PBT M = 1.4571/PBT S = 1.4571/ aluminium (coated) K = 1.4571/ stainless steel	R90 = BSP R9P <sup>2)</sup> = BSP connection with PP enclosure R9T <sup>2)</sup> = BSP connection with PTFE enclosure N90 = NPT N9P <sup>2)</sup> = NPT connection with PP enclosure N9T <sup>2)</sup> = NPT connection with PTFE enclosure	00 = 4-20 mA HART®/ without display/without 0A = 4-20 mA HART®/ without display/ATEX 0I = 4-20 mA HART®/ without display/IECEX H0 <sup>1)</sup> = 4-20 mA HART®/without display (high temp.)/ without	0 = without Y <sup>2)</sup> = special version (acc. to description)
	C = horn-antenna DN80, 3" / (0,2...23 m)	M = 1.4571/PBT S = 1.4571/ aluminium (coated) K = 1.4571/ stainless steel	FBE = DN80 PN25 1.4571 FCE = DN100 PN25 1.4571 FEE = DN150 PN25 1.4571 FBP <sup>3)</sup> = DN80 PP (PN25) FCP <sup>3)</sup> = DN100 PP (PN25) ABE = 3" RF 150 psi 1.4571 ACE = 4" RF 150 psi 1.4571 ABP <sup>3)</sup> = 3" RF PP (150 psi) ACP <sup>3)</sup> = 4" RF PP (150 psi) JBE = JIS 10K 80A 1.4571 JCE = JIS 10K 100A 1.4571 JBP <sup>3)</sup> = JIS 80A PP (10K) JCP <sup>3)</sup> = JIS 80A PP (10K)	HA <sup>1)</sup> = 4-20 mA HART®/without display (high temp.)/ ATEX HI <sup>1)</sup> = 4-20 mA HART®/without display (high temp.)/ IECEX 10 = 4-20 mA HART®/with display/without 1A = 4-20 mA HART®/ with display/ATEX 1I = 4-20 mA HART®/ with display/IECEX D0 <sup>1)</sup> = 4-20 mA HART®/ with display (high temp.)/without	
	D = parabolic-antenna DN150, 6" / (0,4...23 m)		FEE = DN150 PN25 1.4571 FEP <sup>3)</sup> = DN150 PP (PN25) AEE = 6" RF 150 psi 1.4571 AEP <sup>3)</sup> = 6" RF PP (150 psi) JEE = JIS 10K 150A 1.4571 JEP <sup>3)</sup> = JIS 150A PP (10K)	DA <sup>1)</sup> = 4-20 mA HART®/ with display (high temp.)/ATEX DI <sup>1)</sup> = 4-20 mA HART®/ with display (high temp.)/IECEX	

<sup>1)</sup> Only possible with material combination »S« or »K«; not available with PP enclosure

<sup>2)</sup> Not available for Ex version

<sup>3)</sup> Hole pattern as per specification in brackets (xx); p<sub>max</sub> is 3 bar

<sup>4)</sup> Only in combination with process connection "xxP"





**Order Details Integrated Version** (Example: **NRM-7 A P R80 P0 0**)

Model	Antenna/ measuring range	Material antenna/ housing	Process connection	Output/version/ approval	Options
NRM-7	<b>B</b> = horn-antenna DN50/ (0,2...23 m)	<b>P</b> <sup>1)</sup> = PP/PBT <b>M</b> = 1.4571/ PBT	<b>R90</b> = BSP <b>R9P</b> <sup>1)</sup> = BSP connection with PP enclosure <b>R9T</b> <sup>1)</sup> = BSP connection with PTFE enclosure <b>N90</b> = NPT <b>N9P</b> <sup>1)</sup> = NPT connection with PP enclosure <b>N9T</b> <sup>1)</sup> = NPT connection with PTFE enclosure	<b>P0</b> = 4-20 mA HART®/ without display (integrated)/ without	<b>0</b> = without <b>Y</b> <sup>1)</sup> = special version (acc. to description) <b>Y</b> <sup>1)</sup> = special cable length (max. 30 m)
	<b>C</b> = horn-antenna DN80/ (0,2...23 m)	<b>M</b> = 1.4571/ PBT	<b>FBE</b> = DN80 PN25 1.4571 <b>FCE</b> = DN100 PN25 1.4571 <b>FEE</b> = DN150 PN25 1.4571 <b>FBP</b> <sup>2)</sup> = DN80 PP (PN25) <b>FCP</b> <sup>2)</sup> = DN100 PP (PN25) <b>ABE</b> = 3" RF 150 psi 1.4571 <b>ACE</b> = 4" RF 150 psi 1.4571 <b>ABP</b> <sup>2)</sup> = 3" RF PP (150 psi) <b>ACP</b> <sup>2)</sup> = 4" RF PP (150 psi) <b>JBE</b> = JIS 10K 80A 1.4571 <b>JCE</b> = JIS 10K 100A 1.4571 <b>JBP</b> <sup>2)</sup> = JIS 80A PP (10K) <b>JCP</b> <sup>2)</sup> = JIS 80A PP (10K)	<b>PA</b> <sup>3)</sup> = 4-20 mA HART®/ without display (integrated)/ ATEX Ex ia <b>PI</b> <sup>3)</sup> = 4-20 mA HART®/ without display (integrated)/ IECEX	

<sup>1)</sup> Not available for Ex version

<sup>2)</sup> Hole pattern as per specification in brackets (xx); p<sub>max</sub> is 3 bar

<sup>3)</sup> Ex version comes with 5 m cable only

<sup>4)</sup> Only in combination with process connection "xxP"

**Accessories**

Description	Ordering code
HART® USB modem	HARTCOM-0
Display for NRM-4	NRM-300P

Dimensions [mm]

	Aluminium housing 2" horn antenna	Plastic housing 2" horn antenna
Material of wetted parts	1.4571, PTFE	1.4571, PTFE
Process connection	2" BSP, 2" NPT	2" BSP, 2" NPT
Beam angle (-3 dB)	16°	16°
Dead zone L <sub>min</sub> *	200 mm	200 mm

\* Under reference conditions

	Aluminium housing 2" antenna with PP enclosure	Plastic housing 2" PP encapsulated antenna
Material of wetted parts	PP	PP
Process connection	2" BSP, 2" NPT	2" BSP, 2" NPT
Dead zone L <sub>min</sub> *	300 mm	300 mm

\* Under reference conditions

Dimensions [mm] (continued)

	Integrated plastic housing, 2" horn antenna	Integrated plastic housing, 2" PP encapsulated antenna
Material of wetted parts	PP	PP
Process connection	2" BSP, 2" NPT	2" BSP, 2" NPT
Beam angle (-3 dB)	16°	25°-27°
Dead zone L <sub>min</sub> *	200 mm	300 mm

\* Under reference conditions

	Aluminium housing, 2" Tri-Clamp® antenna with PTFE enclosure, hygienic version	Plastic housing, 2" Tri-Clamp® antenna with PTFE enclosure, hygienic version	Aluminium housing, DN50 pipe coupling antenna with PTFE enclosure, hygienic version	Plastic housing, DN50 pipe coupling antenna with PTFE enclosure, hygienic version
Material of wetted parts	1.4571, PTFE	1.4571, PTFE	1.4571, PTFE	1.4571, PTFE
Process connection	2" Tri-Clamp®	2" Tri-Clamp®	DN50 (DIN 11851)	DN50 (DIN 11851)
Dead zone L <sub>min</sub> *	300 mm	300 mm	300 mm	300 mm

\* Under reference conditions

Dimensions [mm] (continued)

	Aluminium housing, horn antenna with flange	Aluminium or plastic housing, parabolic antenna with flange	Stainless steel housing, parabolic antenna with flange	High temperature version, aluminium housing, parabolic antenna with flange
Material of wetted parts	1.4571, PTFE	1.4571, PTFE	1.4571, PTFE	1.4571, PTFE
Process connection	flange	flange	flange	flange
Beam angle (-3 dB)	11°	6°	6°	6°
Dead zone L <sub>min</sub> *	200 mm	200 mm	200 mm	200 mm

\* Under reference conditions

	High temperature version, aluminium housing, 1½" horn antenna	High temperature version, aluminium housing, 2" horn antenna	High temperature version, aluminium housing, horn antenna with flange	High temperature version, aluminium housing, 2" Tri-Clamp® antenna with PTFE enclosure hygienic version
Material of wetted parts	1.4571, PTFE	1.4571, PTFE	1.4571, PTFE	1.4571, PTFE
Process connection	1½" BSP, 1½" NPT	2" BSP, 2" NPT	flange	2" Tri-Clamp®
Beam angle (-3 dB)	19°	16°	11°	25°-27°
Dead zone L <sub>min</sub> *	200 mm	200 mm	200 mm	300 mm

\* Under reference conditions