



# Operating Instructions for Magnetostrictive Level Transmitters

## Model: NMB



We don't accept warranty and liability claims neither upon this publication nor in case of improper treatment of the described products.

The document may contain technical inaccuracies and typographical errors. The content will be revised on a regular basis. These changes will be implemented in later versions. The described products can be improved and changed at any time without prior notice.

© **Copyright**  
**All rights reserved.**

# 1. Contents

---

1. Contents.....	2
2. Note .....	4
2.1 General.....	4
2.2 Hazard warnings.....	4
3. Instrument Inspection.....	5
4. Intended Use.....	6
5. Operating Principle.....	7
5.1 Accessories .....	8
5.2 Special Conditions for Safe Use .....	9
5.3 Technical Description Concerning Explosion Safety.....	9
5.4 Temperature limits .....	10
6. Installation .....	11
6.1 Mounting .....	11
6.2 Wiring.....	13
6.3 Loop current checking .....	14
7. Programming .....	15
7.1 The NRM-300P Display unit .....	16
7.2 Programming with the NRM-300P display unit .....	18
7.3 Programmable features description .....	20
8. Error codes .....	26
9. Menu map .....	27
10. Maintenance .....	29
11. Technical Information.....	29
12. Order Codes .....	29
13. Dimensions .....	29
14. Disposal .....	29
15. EU Declaration of Conformance .....	30
16. EU Declaration of Conformity (ATEX).....	31
17. ATEX certificate .....	32

**Manufactured and sold by:**

Kobold Messring GmbH  
Nordring 22-24  
65719 Hofheim  
Tel.: +49(0)6192-2990  
Fax: +49(0)6192-23398  
E-Mail: [info.de@kobold.com](mailto:info.de@kobold.com)  
Internet: [www.kobold.com](http://www.kobold.com)

## 2. Note

### 2.1 General

Before unpacking and commissioning the device, the operating instructions and the “General Safety Instructions” document must be read and followed carefully. The general safety instructions, the operating instructions, the data sheet as well as approvals and further information can be downloaded via the QR code on the device or under the respective product on [www.kobold.com](http://www.kobold.com).

Due to technical changes, the device documentation available online may not always correspond to the product version you have purchased. If you need an instruction manual that corresponds to the purchased product version, you can request it from us free of charge by email ([info.de@kobold.com](mailto:info.de@kobold.com)) in PDF format, specifying the relevant invoice number and serial number. If you wish, the operating instructions can also be sent to you by post in paper form.



Operating instructions, data sheet, approvals and further information via the QR code on the device or via [www.kobold.com](http://www.kobold.com)





The devices are only to be used, maintained and serviced by persons familiar with these operating instructions and in accordance with local regulations applying to Health & Safety and prevention of accidents.

When used in machines, the device should be used only when the entire machine fulfils the EU machinery directive.

### 2.2 Hazard warnings

The following instructions are intended to ensure your personal safety and to prevent damage to the product described or connected devices. Safety instructions and warnings to prevent danger to the life and health of users or maintenance personnel, or to prevent damage to property, are highlighted in this documentation using the symbols defined here. *The symbols and terms used have the following meaning in the documentation itself:*

Symbol	Explanation	Symbol	Explanation
 Note	Is important information about the product, the handling of the product or the respective part of the documentation to which particular attention should be drawn.	 Caution	Means that minor personal injury or minor property damage may occur if proper precautions are not taken.

Symbol	Explanation	Symbol	Explanation
 Warning	Indicates that serious personal injury or substantial property damage may occur if proper precautions are not taken.	 Danger	Means that death can occur if proper precautions are not taken.
 Warning	Attention: Hot surface!	 Warning	Warning: Dangerous electrical voltage

### 3. Instrument Inspection

Instruments are inspected before shipping and sent out in perfect condition. Should damage to a device be visible, we recommend a thorough inspection of the delivery packaging. In case of damage, please inform your parcel service / forwarding agent immediately, since they are responsible for damages during transit.

**Scope of delivery:**

The standard delivery includes:

- Magnetostrictive Level Transmitters    model: NMB
- 2 cable glands (M20x1.5)
- 1 x gasket (Klingerit oilit) for BSP threads only

## 4. Intended Use

---

Flawless operation of the device can only be guaranteed if all aspects in these operating instructions are adhered to.



The manufacturer assumes no responsibility for any damage resulting from improper use. The user assumes all responsibility for such usage

NMB series working on the magnetostrictive principle are suitable for high accuracy level measurement of storage tanks. Due to their high temperature and pressure rating these units can also be used for level gauging of technological tanks. The most suitable applications are with liquids free of solid particles and with low viscosity both in ordinary and hazardous locations.

Its high precision renders NMB suitable for custody transfer measurement of valuable liquids such as fuels, solvents, alcohol distillates, etc. Plastic version of the series substantially expands the field of application by a wide range of aggressive materials.



### 5.1 Accessories

Code	Description	Image
<b>HARTCOM-x</b>	HART® modem (Download of configuration software NUS-NTB-NRM-SW at <a href="http://www.kobold.com">www.kobold.com</a> )	
<b>NRM-300P</b>	Plug-in graphical display module	
<b>NUS-NTB-NRM-SW</b>	Configuration software for remote programming with PC (FREE download)	

### Process Connections\*

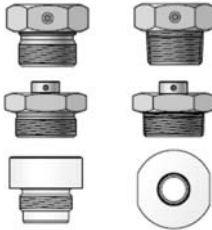
Code	Description	Image
<b>ZUB-NMS/B...</b>	DIN and ANSI flanges	 ZUB-NMS/BFEA402
	Sliding sleeve 1.4571 (316Ti) or PVDF: 1", 2" BSP/ NPT process connection	

\* The process connections and special seals are ordered separately and must be specified in the text part of the order

## 5.2 Special Conditions for Safe Use

Aluminium housing of the unit should be connected to the equipotential (grounding) system. For field connections, use cable rated +20 °C greater than Maximum Ambient Temperature and seal all threaded entries at enclosure with suitably rated sealing components.

In case of  $\text{Ex}$  II 1 G Ex ia IIB T6...T5 Ga protected equipment version with aluminium alloy enclosure, the aluminium-content of enclosure exceeds the limit, thus the equipment must be protected against impact and friction effects and may only be powered by a duly approved and certified Ex ia IIB intrinsically safe loop according to the technical data.

Regarding information on the dimensions of flameproof joints, please contact the manufacturer.

The risk of electrostatic discharge shall be minimized at installation, especially plastic covered equipment with order code starting with NMB-E or NMB-G may be electrostatically charged, therefore:

- Medium to measure must be electrically conductive and with specific resistance not exceeding the value of  $10^4 \Omega\text{m}$  even on the most unfavourable places and under the most unfavourable conditions.
- Speed as well as way of filling and emptying should be chosen according to the medium.

For installation in environment with Maximum Ambient Temperature above +55 °C refer to Section 5.4. TEMPERATURE LIMITS

## 5.3 Technical Description Concerning Explosion Safety

Type	NMB-xxxxxxx5x NMB-xxxxxxx6x NMB-xxxxxxx7x NMB-xxxxxxx8x	NMB-xxxxxxxCx NMB-xxxxxxxDx	NMB-xxxxxxxAx NMB-xxxxxxxBx	NMB-xxxxxxx9x
Ex marking (ATEX)	$\text{Ex}$ II 1 G Ex ia IIB T6...T5 Ga 0 ... 18 m	$\text{Ex}$ II 1/2 G Ex db ia IIB T6...T5 Ga/Gb 0 ... 10 m	$\text{Ex}$ II 2 G Ex db IIB T6...T5 Gb 0 ... 10 m	$\text{Ex}$ II 1 G Ex ia IIB T6...T5 Ga 0 ... 18 m
Ex marking (IECEx)	Ex ia IIB T6...T5 Ga 0 ... 18 m	Ex db ia IIB T6...T5 Ga/Gb 0 ... 10 m	Ex db IIB T6...T5 Gb 0 ... 10 m	-
Cable entry	M20×1.5 cable gland	M20×1.5 Certified "Ex d" metal cable gland		-
Cable outer diameter	Ø 7 ... 13 mm	Ø 9 ... 11 mm		
Ex power supply, Intrinsic safety data	U <sub>i</sub> = 30 V, I <sub>i</sub> = 140 mA, P <sub>i</sub> = 1 W, C <sub>i</sub> ≤ 15 nF, L <sub>i</sub> ≤ 200 µH		U <sub>i</sub> : 12.5 ... 36 VDC I <sub>max</sub> : 140 A	U <sub>i</sub> = 30 V, I <sub>i</sub> = 140 mA, P <sub>i</sub> = 1 W, C <sub>i</sub> ≤ 25 nF, L <sub>i</sub> ≤ 210 µH
Comment	The NMB-xxxxx5xx9x type instrument is IP68-rated. The cover, cable gland, cable, and the plug are glued and cannot be opened!			

### 5.4 Temperature limits

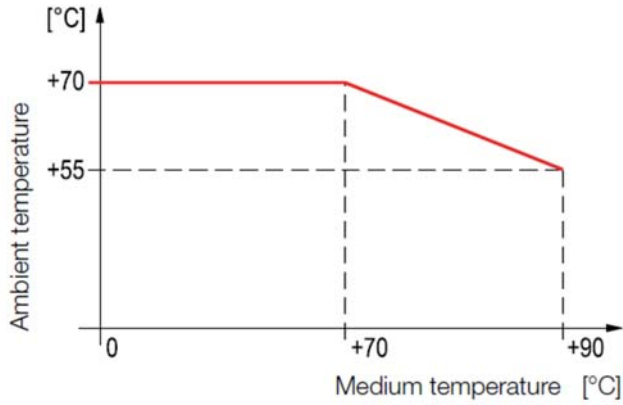
Type	Temperature class	Ambient temperature*	Medium temperature
Rigid probe	T6	-40...+70 °C	+80 °C
Flexible probe			+70 °C
Rigid probe	T5	-40...+55 °C	+90 °C
Comment	* In the case of models equipped with a display, the lower ambient temperature is limited to -25 °C		
	 <p>The graph plots Ambient temperature [°C] on the y-axis against Medium temperature [°C] on the x-axis. The y-axis has markers at +70 and +55. The x-axis has markers at 0, +70, and +90. A red line starts at (0, +70), remains horizontal until x = +70, and then slopes downward to the point (+90, +55). Dashed lines indicate the coordinates of the key points on the graph.</p>		

## 6. Installation

---

### 6.1 Mounting

- When choosing the installation place please ensure proper space for later calibrations, verification or maintenance service.
- Waving, vortex or vibration effects have negative influence on the measurement accuracy. To avoid these effects, the mounting placement should be as far as possible from the sources of these disturbing effects for instance from openings of filling or emptying. These effects can be attenuated in applications with rigid tube probes by the use of stilling pipe along the whole probe. Please consult with a Kobold Messring distributor!
- To ensure consistent and durable operation the measurement medium should be free of suspended solid materials, which could stick between the float and the probe.
- The unit should be protected against direct heat radiation.
- Prior to the installation the mounting dimensions of the unit and the tank as well as the calculations should be checked carefully.
- Prior to the installation a preliminary operation check is suggested.
- If necessary to change the default factory settings the programming should be performed in accordance to the description in the 7th chapter.
- The units are offering a wide variety of process connections according to the available order codes. The tank opening should be fit for the selected level transmitter by means of the insertion hole is bigger than the float diameter. If this is not possible the float has to be removed from the probe and when the unit is mounted into the tank the float can be mounted from inside of the vessel. The "UP" marking on the float ensures that the float is mounted back in the correct position. See the drawing! Prior to finishing the mounting, the spacer needed to assemble back between the float and the counterweight.

- In case of rigid probes with PFA coating, the probe length can be adjusted. Nevertheless, the probe length outside the tank should not be greater than 200 mm.

The models with flexible probe are supplied with a counterweight at the end of the probe for straightening the cable probe and fixing it in the right position. The weight and the fastening nut are included with the instrument. When lowering down the flexible probe (with the weight at the end) to the bottom of the tank, special care has to be taken to avoid twisting and kinking of the coil. Do not coil the cable less than 60 cm in diameter. Dropping or twitching of the cable probe may damage the unit. To avoid the float to falling down and hitting the weight the float should be placed to the bottom position next to the weight. The weight should not contact with the tank bottom. The proper straightening of the cable probe can be checked by the analogue output or by the display. If the float is at the bottom position,  $I_{OUT}$  should be equal to 4 mA or the displayed measurement value should be 0 mm.

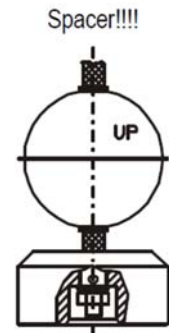

 <p>Caution</p>	<p>Attention! In order to avoid damaging the probe, do not put it to torsion when installing or removing the unit. Therefore, special care has to be taken when the process connection is being screwed into or out of the flange. The best is to hold the rigid part of the probe with a suitable tool as long as the process connection is tightened to its place. Sliding sleeve must not be loosened during operation.</p>
---	--

## 6.2 Wiring

This transmitter is designed to operate on 12.5...36 V DC power only (for Ex transmitters: 12.5...30 V DC).

The measured voltage on the terminals of the unit should be at least 12.5 V. Using transmitter with HART a terminal resistance with a minimum value of 250 Ω should be applied.

The power supply should be interconnected with the unit with twisted, shielded cable that can be pulled through the cable conduit. The cable can be connected to the terminal strip after removing the cover and the display unit.

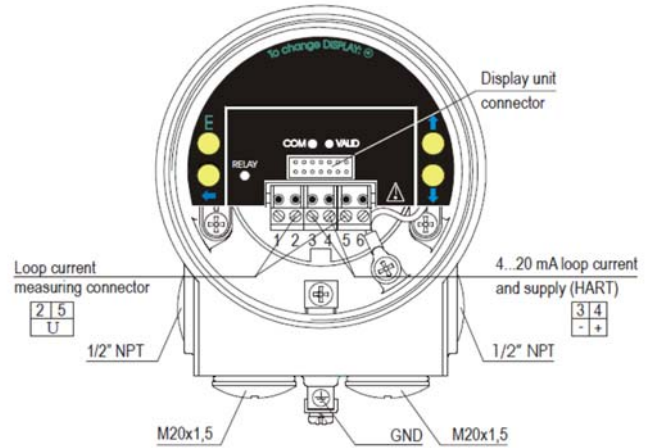

<p><b>NOTE</b></p>	<p><b>CAUTION:</b> the enclosure of the transmitter should be grounded. Grounding resistance should be &lt; 2 Ω. Shielding of the interconnecting cable should be grounded at the control room side. To avoid disturbing noises the interconnecting cable must not be led near to high voltage cables. Especially critical are inductive couplings of AC harmonics against which the protection of shielding is not effective.</p>
<p>Note</p>	

	<p>The unit may be damaged by electrostatic discharge (ESD), via its terminal thus used commonly precautions should be applied to avoid electrostatic discharge e.g. touching a properly grounded point before removing the cover of the enclosure.</p>
<p>Warning</p>	

Possible electrostatic discharge may damage the unit. Thus, the internal electric connection points must not be touched by hand.

### 6.3 Wiring of Ex certified units

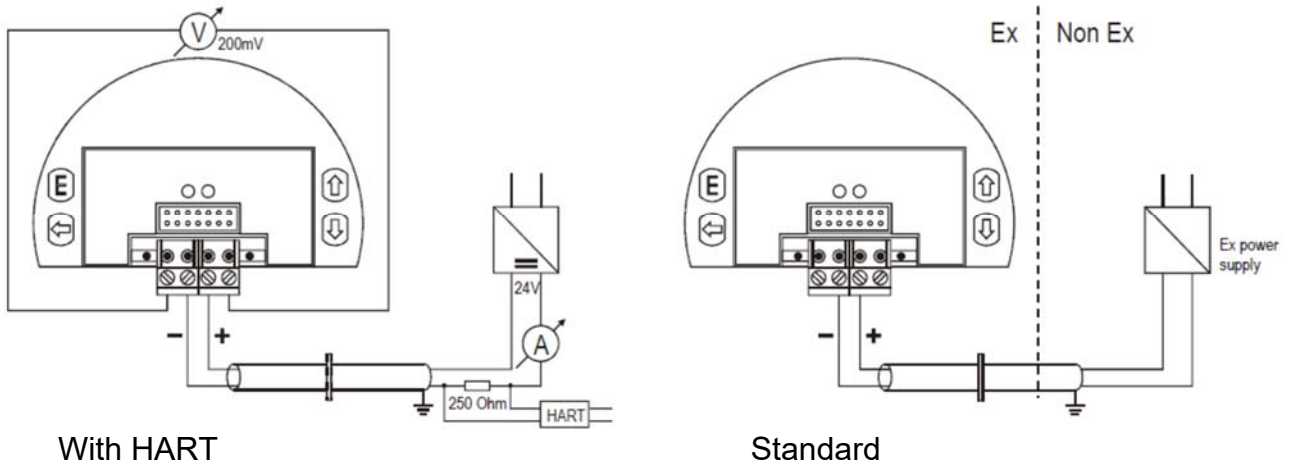

### 6.4 Loop current checking

After removing the cover and the display module the actual loop current can be measured with an accuracy of 0.5% by connecting a voltmeter (in the range of 200 mV) to the points indicated on the drawing above.

<div style="background-color: #f4a460; padding: 2px; font-weight: bold; font-size: 0.8em;">NOTE</div> <div style="border: 1px solid #ccc; height: 20px; width: 100%;"></div> <div style="border: 1px solid #ccc; height: 20px; width: 100%;"></div> <div style="border: 1px solid #ccc; height: 20px; width: 100%;"></div> <p>Note</p>	<p>The loop current measuring connectors are designed for checking the proper installation only, they cannot be used as a permanent secondary voltage output. Testing and installation under explosive atmosphere, requires approved test equipment and trained personnel!</p>
--	--

## 7. Programming

---

NMB transmitters can be programmed by two basic ways.

- Programming with NRM-300P display unit, (see chapter 5.2).
- Accessing all the configurable parameters allows full modification of the operation (measurement configuration, zero point offset, output assignments, measurement optimisation, entering dimensions of 11 kind of tanks into parameters, 99-point linearization table).

Depending on required certification, some models may not include the NRM-300P display unit. The NMB transmitters are fully operational without the NRM-300P display unit, the NRM-300P module is needed only for parameter configuration and / or displaying measurement values.

**The device measures during the programming procedure in accordance to the previous parameter set. The new, modified parameter set becomes valid after returning into Measurement Mode!**

If the transmitter is left in Programming Mode by mistake, it will automatically return to Measurement Mode after 30 minutes and modifications will be unsaved.

### Factory settings

The NMB transmitters will be delivered with the following Factory default values:

- ⇒ Measurement mode: level (LEV). Displayed value shows level.
- ⇒ Current output and bar graph on the right side are proportional to the level.
- ⇒ 4 mA and 0% are assigned to minimal level (lowest position of the float).
- ⇒ 20 mA and 100% are assigned to maximal level (highest position of the float).
- ⇒ Error indication by the current output: holds last value of the output.
- ⇒ Level tracking time constant: 0 sec.

The transmitter measures the distance (DIST) from the highest position of the float as primary value. This distance can be processed, displayed in the following units: m, cm, mm, feet, or inch. Since the measurement range of the device is given, the electronics calculate the actual level (LEV). If the mechanical dimensions of the proper mounting position of the device – distance between the lowest position of the float and the bottom of the tank – are also known, then the measured level can be more accurate by this data. The calculated level is used for volume (VOL), or mass (MASS) calculation, and this is the input value of the 99-point linearization process (VMT).

## 7.1 The NRM-300P Display unit

### 7.1.1 The NRM-300P module

The NRM-300P is a 64 × 128 dot-matrix LCD display which can be plugged into the transmitter. (Universal – usable in other Kobold Messring devices as well – provided that the system software supports NRM-300P.)

 Caution	<p><b>Warning!</b>                  The NRM-300P module is based on LCD technology, so please make sure it is not exposed to permanent heat or direct sunlight, in order to avoid damage of the display unit. If the instrument cannot be protected against direct sunlight or high temperature that is beyond the standard operating temperature range of the NRM-300P, please do not leave the NRM-300P display in the instrument.</p>
--	--

### Displaying with the NRM-300P module

Elements of the display:

1. Primary value (PV), as per BASIC SETUP / PV. MODE.
2. Mode of primary value calculation, as per BASIC SETUP / PV. MODE.
3. Type and value of the initial value for primary value calculation:
  - In case of level measurement: distance
  - In case of volume or mass calculation: level
4. Trend direction arrows. The empty triangle shows when the measured value is small, the filled triangle shows large-scale change. The measured value is constant if none of the arrows are shown.
5. Measured value in relation to measurement range (Sensor range) in a bar graph.
6. Indication of primary value simulation. In this case the display and output will show the values of the simulation and not the measured value.
7. Indication of the Volume/Mass calculation table (Volume/Mass Table – VMT)

During active simulation the critical measurement errors will be displayed to give information to the user.

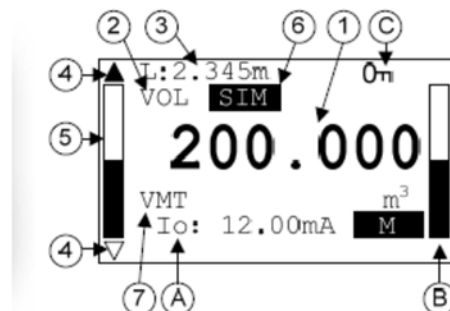

A., Calculated value of the output current. After the dimension, the mode of current output is indicated by inverse inscription:

**M** Manual mode (see: chapter 7.3.2.1)

**H** HART address is not 0, so output current has become overwritten to 4 mA (see: chapter 7.3.2.1)

**E!** Analogue transmission reacts to a programmed failure condition if an upper or lower fault current is programmed (see: chapter 7.3.2.4)

B., Output range (4...20 mA) indicated in a bar graph.

C., Indication of Menu Lock:

- If key symbol is visible, the unit is protected with a password. When entering the menu, the instrument asks for the correct password.
- If REM message is visible, the instrument is in remote programming mode and the menu cannot be accessed.

Errors occurred during the measurement can be seen at the bottom line of the display.

### Information displays:

Press  $\downarrow$  button to cycle between the information displays.

1. The general information display (DEV. INFO): overall running time (OV. RUN TIME), run time after power on (RUN TIME), type of interface (INTERFACE), relay (RELAY) and logger (LOGGER) indication.
2. Sensor information display

The informative display switches back to main screen after 30 seconds. By pressing the  $\uparrow$  button the user can get back to main screen at any time. Pressing the  $\text{E}$  button in any of the displays the user can enter to menu. After exiting the menu, always the main screen will be shown.

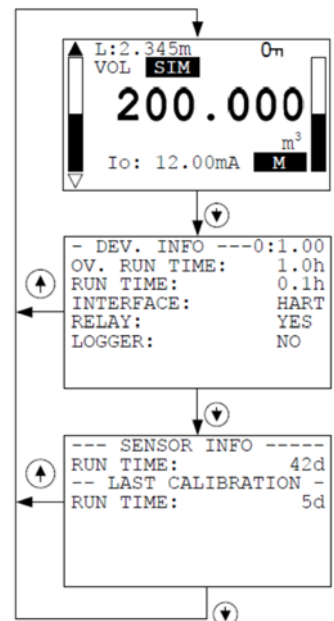

## 7.2 Programming with the NRM-300P display unit

When entering the menu the instrument makes a copy of the actual parameters, all changes are done to this duplicated parameter set. During programming the instrument keeps measuring and transmitting with the current (and intact) parameter set. After exiting the menu, the instrument replaces the original parameters with the new parameter set and will measure according the new parameters. This means that the change of the parameters does not become immediately effective when pressing the **E** button! Entering the menu can be done by pressing the **E** button while exiting the menu can be done by pressing the **←** button.

If the instrument is left in programming mode after 30 mins it will automatically return to measuring mode. If the NRM-300P display is removed during programming the instrument immediately returns to measuring mode.

As programming with NRM-300P (manual programming) and HART (remote mode) programming is not possible at the same time use only one programming method at a time. Measured values can be read out through HART at any time.

### 7.2.1 Elements of programming interface

The parameters of the instrument are grouped according to their functions. The programming interface consists of lists, dialog windows, edit windows and report windows.

#### Lists

Navigation between the lines of a list can be done by pressing **↑** / **↓** buttons. Pressing the **E** button activates a list item. Selected list item is marked with inverse colour. Exit from a list by pressing the **←** button.

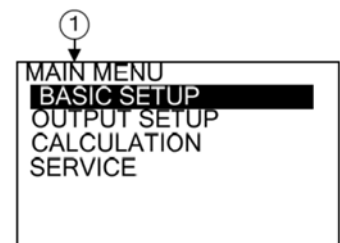

#### Menu list

Menu list is a specialized list. Its characteristic is that upon selecting a list item we directly get into another list, and these lists are opening from each other in different levels. The menu header (1) helps to navigate. Entering the menu can be done by pressing the **E** button. Navigation between the menu items can be done by pressing the **↑** / **↓** buttons. Enter to the selected menu by pressing the **E** button. The selected list item is marked with inverse colour. Exit from a submenu with **←** button. Pressing the **←** button in the main menu will exit programming mode and the instrument will return to measuring mode.

#### Dialog window

The system sends messages or warnings using dialog windows. These usually can be acknowledged by pressing the **←** button or the user can choose between two options (usually YES or NO) by pressing **←** / **↓** buttons. In some cases, to correct an error one of the parameters has to be changed.

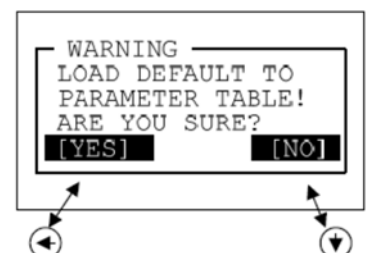

## Edit window

An edit window is used for modifying a numeric parameter value.

The selected character can be changed using the  $\uparrow$  /  $\downarrow$  buttons. The cursor can be moved to left, using the  $\leftarrow$  button.

The direction of the cursor movement through the digits is right to left. Changed value can be validated by pressing the  $\text{E}$  button.

The software checks if the entered value is appropriate, exiting the edit window is only possible after entering a correct value.

If the entered value is uninterpretable the software sends an error message in the bottom line (1) of the display. The display gives the same error message, independently of the measured value and the measurement principle.

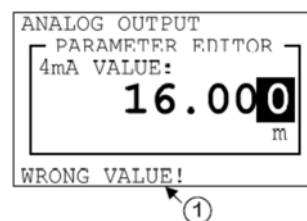

## Edit window – button combinations

In the edit window the following button combinations are available:

Recalling the parameters to the state before editing ( $\leftarrow$  +  $\uparrow$  , pressed for 3 secs);  
 Recalling default parameters ( $\leftarrow$  +  $\downarrow$  , pressed for 3 secs);

Inserting (currently) measured value to the edit window ( $\leftarrow$  +  $\uparrow$  , pressed for 3 secs)

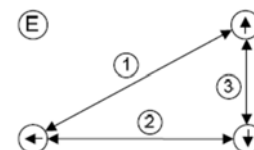

Only for certain parameters!

## Main menu

BASIC SETUP	Parameter group of the basic measurement parameters
OUTPUT SETUP	Parameter group of the output parameters
CALCULATION	Calculations
SERVICE	Service functions, calibration, test and simulation

## 7.3 Programmable features description

### 7.3.1 Basic measurement settings

#### 7.3.1.1 Units

##### Default measuring unit:

Parameter:	P00: c, where a: 0, 1.	Default value:	EU
Menu path:	BASIC SETUP / UNITS/ENGINEERING SYSTEM	(for USA versions: US)	
Description:	This should be configured as the first step of the programming. Here you can choose the default unit system:		
	<ul style="list-style-type: none"> <li>• EU European unit system</li> <li>• US Anglo-Saxon unit system</li> </ul>		

##### Dimension of the default measuring unit:

Parameter:	P00: b, and P02: b	Default value:	mm, m <sup>3</sup> , t
Menu path:	BASIC SETUP / UNITS/ENGINEERING UNITS	(for USA versions: inch, ft <sup>3</sup> , t)	
Description:	The dimension of the unit can be specified in this menu:		
	<ul style="list-style-type: none"> <li>• BASIC UNITS (mm, cm, m, ft, inch)</li> <li>• VOLUME UNITS (m<sup>3</sup>, l)</li> <li>• MASS UNITS (t, t)</li> </ul>		

If the unit is changed, after a warning message the device resets all the parameters.

#### 7.3.1.2 PV mode

Parameter:	P01: b a	Default value:	DIST
Menu path:	BASIC SETUP / PV MODE		
Description:	This mode determines the primary value and the displayed value. It also determines the value which will be proportional to the output current.		
	<ul style="list-style-type: none"> <li>• DISTANCE</li> <li>• LEVEL</li> <li>• VOLUME</li> <li>• MASS</li> </ul>		

#### 7.3.1.3 Damping time

Parameter:	P20	Default value:	0 sec
Menu path:	BASIC SETUP / DAMPING TIME		
Description:	Damping time is used to damp the unwanted fluctuations of the output and display. If the measured value changes rapidly the new value will settle with 1% accuracy after this set time. (damping according to an exponential function).		

#### 7.3.1.4 Application

Parameter:	P0: a, where a: 0, 1.	Default value:	NORMAL
Menu path:	BASIC SETUP / APPLICATION		
Description:	Application mode, refers to the mounting position of the devices, and affects the function of error indications.		
	<ul style="list-style-type: none"> <li>• NORMAL Device sensor is in the tank. Every error indication in normal mode.</li> <li>• BYPASS Device sensor is outside the tank in a measuring tube. The „SIGNAL IN N.D.B.“ and „SIGNAL IN F.D.B.“ error indication are inactive.</li> </ul>		

#### 7.3.1.5 Installation mode (ONLY USD (UpSide Down) – „Reverse installation position“ devices)

Parameter:	P0: d, where d: 0, 1.	Default value:	NORMAL
Menu path:	BASIC SETUP / MOUNTING MODE		
Description:	It reverses the reference points of the level calculation in accordance with the mounting position.		
	<ul style="list-style-type: none"> <li>• NORMAL Device housing on top, sensor on bottom (normal position)</li> <li>• UPSIDE DOWN Device housing on bottom, sensor on top (reverse position)</li> </ul>		

## 7.3.2 Analogue output

### 7.3.2.1 Output current mode

Parameter:	P12: b, where a: 0, 1.	Default value:	AUTO
Menu path:	OUTPUT SETUP / ANALOG OUTPUT / CURRENT MODE		
Description:	Transmission mode of the current output [AUTO, MANUAL]		
	<ul style="list-style-type: none"> <li>• <b>AUTO</b> The output current is calculated from the measured value, output is active.</li> <li>• <b>MANUAL</b> The output current is fixed at a constant (set) value (see 5.3.2.5). In this mode the setting of the error current is irrelevant. The set (current) value overwrites the 4 mA output of HART multidrop mode!</li> </ul>		

### 7.3.2.2 Output current value 4 mA

Parameter:	P10	Default value:	0
Menu path:	OUTPUT SETUP / ANALOG OUTPUT / 4 mA VALUE		
Description:	Measured value assigned to 4 mA. The transmitted value is in accordance to the primary value (PV) (P01: a). Assignment can be done that the change in measured value and the change in the output value are the same (normal), or opposite directional (inverse operation). For example: 1 m level is 4 mA, 10 m level is 20 mA, or 1 m level is 20 mA and 10 m level is 4 mA.		

### 7.3.2.3 Output current value 20 mA

Parameter:	P11	Default value:	Active measurement range
Menu path:	OUTPUT SETUP / ANALOG OUTPUT / 20 mA VALUE		
Description:	Measured value assigned to 20mA. The transmitted value is in accordance to the primary value (PV) (P01: a). Assignment can be done that the change in measured value and the change in the output value are the same (normal), or opposite directional (inverse operation). For example: 1 m level is 4 mA, 10 m level is 20 mA, or 1 m level is 20 mA and 10 m level is 4 mA.		

### 7.3.2.4 Output current error mode

Parameter:	P12: a, where a: 0, 1, 2	Default value:	HOLD
Menu path:	OUTPUT SETUP / ANALOG OUTPUT / ERROR MODE		
Description:	Error indication by the current output		
	<ul style="list-style-type: none"> <li>• <b>HOLD</b> Error indication has no effect on the output current.</li> <li>• <b>3.8 mA</b> Error indication: the output current gets 3.8 mA.</li> <li>• <b>22 mA</b> Error indication: the output current gets 22 mA.</li> </ul>		
	<b>Warning</b> This error indication is active unless the failure is fixed, or until the failure terminates.		

### 7.3.2.5 Fixed output current

Parameter:	P08	Default value:	4 mA
Menu path:	OUTPUT SETUP / ANALOG OUTPUT / MANUAL VALUE		
Description:	Parameter for setting the fixed output current Values between 3.8 and 20.5 can be entered. The output current will be set to the entered value and analogue transmission will be suspended (see: 5.3.2.1). This error indication overrides all other error indication.		

### 7.3.3 Digital output

#### 7.3.3.1 HART polling address (if there is a HART option in the device)

Parameter:	P19	Default value:	0
Menu path:	OUTPUT SETUP / SERIAL OUTPUT / ADDRESS		
Description:	HART polling address (only HART capable types) The polling address can be set between 0 and 15. For a single instrument the polling address is 0 and the output is 4...20 mA (analogue output). If multiple units are used in HART Multidrop mode (max. 15) the polling addresses should differ from 0 (1 – 15), in this case the output current will be fixed at 4 mA.		

### 7.3.4 Calculation

#### 7.3.4.1 Zero point offset (Distance between the lowest position of the float and the bottom of the tank)

Parameter:	P04	Default value:	0
Menu path:	CALCULATION / LEVEL OFFSET		
Description:	This Parameter is used for zero point offset. In level measurement mode the zero level is meant at the lowest position of the float. Due to the construction of the device, it cannot able to measure the level through the whole height of the tank, because it may not reach the bottom of the tank. In this Parameter the distance between the lowest position of the float and the bottom of the tank can be entered. The offset value will be a negative value (the value of the Parameter is always the distance between the lowest position of the float and the zero point offset of the measurement) this negative number should be entered into the Parameter if the measurement range needs to be decreased virtually. The absolute value of this number shall be less than the active measurement range. Factory default Parameter value shall be used if there is no need to use zero point offset. (See: Basic concept of Measurement on the 2 <sup>nd</sup> page). Wrong configuration of the zero point offset can result negative level display. Negative level is not right or normal. However there is no error indication on negative level display, it cannot be used for 4...20 mA programming or volume / mass calculations.		

#### 7.3.4.2 Calculation mode

Parameter:	P47: a, where a: 0,1.	Default value:	0
Menu path:	CALCULATION / V/M CALC. MODE		
Description:	Calculation of the volume and mass can be performed with two ways: <ul style="list-style-type: none"> <li>• TANK FUNCTION/SHAPE – volume and mass calculation with a tank shape formula. Entering this menu point table is automatically OFF.</li> <li>• V/M TABLE – volume and mass calculation with a table. Entering this menu point table is automatically ON.</li> </ul>		

#### 7.3.4.3 Tank function/shape

Parameter:	P40: a, where a: 0,1, 2, 3, 4.	Default value:	0
Menu path:	CALCULATION / V/M CALC. MODE / TANK FUNCTION/SHAPE		
Description:	<ul style="list-style-type: none"> <li>• Standing cylindrical tank</li> <li>• Standing cylindrical tank with conical bottom</li> <li>• Standing rectangular tank with or without chute</li> <li>• Lying cylindrical tank</li> <li>• Spherical tank</li> </ul>		

### 7.3.4.4 Tank bottom shape

Parameter: P40: b, where a: 0,1, 2, 3. Default value: 0  
 Menu path: CALCULATION / V/M CALC. MODE / TANK FUNCTION/SHAPE  
 Description: This menu only appears, if it has an importance on the selected type!

- SHAPE1
- SHAPE2
- SHAPE3
- SHAPE4

### 7.3.4.5 Tank dimensions

Parameter: P41-P45 Default value: 0  
 Menu path: CALCULATION / V/M CALC. MODE / TANK FUNCTION/SHAPE  
 Description:

- DIM1 (P41)
- DIM2 (P42)
- DIM3 (P43)
- DIM4 (P44)
- DIM5 (P45)

Standing cylindrical tank with hemispherical bottom a = 0

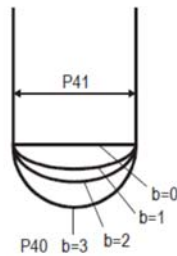

Standing cylindrical tank with conical bottom a = 1 ; b = 0

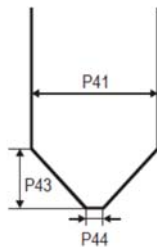

Standing rectangular tank with or without chute a = 2 ; b = 1

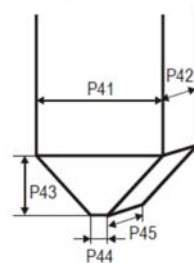

If no chute: P43, P44 and P45 = 0

Lying cylindrical tank a = 3

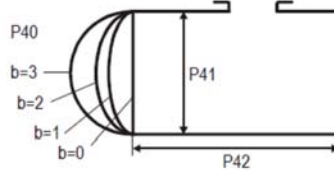

Spherical tank a = 4 ; b = 0

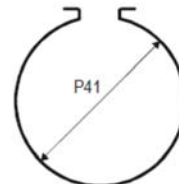

## 7.3.4.6 Volume and mass table

Parameter: -  
 Menu path: CALCULATION / V/M CALC. MODE / V/M TABLE  
 Description:
 

- View/Edit table
- Add item
- Delete item

If none of the formulas match perfectly to the characteristics of the needed tank, there is a possibility to use table calculation mode. The device can handle a 99-point table on this purpose and counts values between the neighbouring point pairs with linear interpolation.

The input (left) side of the table contains the level data, the output (right) side contains the volume or mass data. The first point pair of the table should be 0.0. If a long table wanted to be shortened, 0.0 point pair should be entered into the last item of the table. The device modifies the unused point pairs automatically in the background into 0.0. The status (ON or OFF) of the table is shown on a warning message (1) on the bottom line of the display.

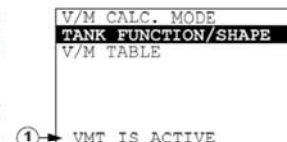

All modifications are done on a temporary table. This temporary table becomes valid after exiting. Modifications during the programming procedure have no effect on the measurement and the transmitting.

Entering the point pairs can be done in arbitrary order, because the device sorts according to ascending order. Both sides of the table have to be strictly monotonic increasing. In case of any error, warning message (see: chapter 6) will appear. When entering again the table inscription indicates the first wrong line.

### View table:

In VIEW/EDIT TABLE menu point items of the ordered table can be checked. For moving in the list use the  $\uparrow$  and  $\downarrow$  buttons, for editing the selected item use the  $\text{E}$  button. Exiting from the list can be done by pressing the  $\leftarrow$  button.

### Edit table:

Adding a point pair (ADD ITEM) to the list or pressing  $\text{E}$  button on an existing item, an edit screen will appear. In this edit screen there are two editing field. Both editing field work as same as editing a Parameter. Getting from the first field to the second field press the  $\text{E}$  button. Pressing  $\text{E}$  button in the second field it will return to the previous menu point. Exiting from the last field, the device performs the ordering of the table.

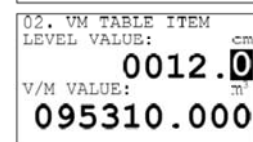
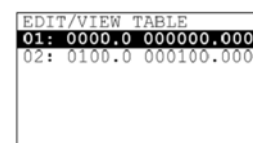

### Delete item

Moving in the list can be done with  $\uparrow$  and  $\downarrow$  buttons, for deleting an item press the  $\text{E}$  button on the selected item. Exiting from the list can be done by pressing the  $\leftarrow$  button. The table has to contain at least 2 items.

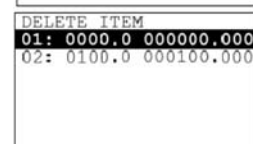

## 7.3.5 Service functions

### 7.3.5.1 Security codes

#### User codes

Menu path: SERVICE / SECURITY / USER LOCK  
 Description: Setting or unlocking the user security code.

The instrument can be protected against unauthorized programming with a 4-digit PIN (Personal Identification Number) code. If either of the digits differs from 0 the code is active. If zero is specified, then the secret code has been deleted! In case of Active code, this code is requested at menu entry.

#### Service code

Menu path: SERVICE / SECURITY / SERVICE LOCK  
 Description: Setting of the service code.  
 Only for trained personnel!

### 7.3.5.2 Current output test

Parameter: P80  
 Menu path: SERVICE / OUTPUT TEST / ANALOG OUTPUT  
 Description: Loop current test (mA)

Entering this Parameter the current value which is proportional to the actual measurement value will appear on the display and the output. In loop current test mode, values between 3.9 and 20.5 can be entered. The output current will be set to the entered value. The measured current on the output should be equal to the set value. In test mode a dialog window warns the user of the fixed output current until the user exits the warning message window. Exiting can be done by pressing the  $\leftarrow$  button.

### 7.3.5.3 Distance simulation

This function facilitates the user to be able to check the calculations (tank formula, table), outputs, and the additional processing instruments connected to the output. NMB transmitters can perform simulation on the value of a constant or a variable. To start simulation the instrument must return to Measurement mode. In Measurement mode if simulation is in progress, an inverse SIM caption appears on the display.

#### Simulation mode

Parameter: P84; a, where a: 0, 1, 2, 3. Default value: OFF  
 Menu path: SERVICE / DIST SIMULATION / MODE  
 Description:

Simulation mode:  
**OFF** No simulation  
**FIX VALUE** Value of the simulated distance is set according to the lowest value of the simulation.  
**TRIANGLE WAVE** Value of the simulated distance changes linearly between the lowest and highest values with an adjustable cycle time.

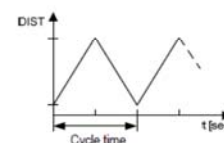

**SQUARE WAVE** The simulated value jumps between the lowest and highest values with an adjustable cycle time.

#### Simulation cycle

Parameter: P85 Default value: 60 sec  
 Menu path: SERVICE / DIST. SIMULATION / TIME  
 Description: Cycle time of the simulation

#### Bottom value of the simulation

Parameter: P86 Default value: 0 mm  
 Menu path: SERVICE / DIST. SIMULATION / BOTTOM VALUE  
 Description: Lowest value of the simulation

#### Upper value of the simulation

Parameter: P87 Default value: Programmed measurement range  
 Menu path: SERVICE / SIMULATION / UPPER VALUE  
 Description: Highest value of the simulation

### 7.3.5.4 Load default values

Menu path: SERVICE / DEFAULTS / LOAD DEFAULT  
 Description: This command loads all default values of the instrument. After loading the default values the parameters can freely be changed, the effect of the changes does not affect the measurement until the user exits programming mode and returns to measurement mode. Before loading the defaults the software asks for a confirmation warning the user that all user parameters will be lost!

### 7.3.5.5 Service distance offset

Parameter: P05 Default value: 0 mm  
 Menu path: SERVICE / SERVICE DIST OFFSET  
 Description: There is a possibility to display auxiliary service information on the bottom line of the screen. This information is useful when verifying measurement is performed with a hand-instrument and zero point of this device is not the same as the highest position of the float. In this case a distance should be entered into this Parameter which is the distance between the highest position of the float (which is the zero point of the measurement range) and the zero point of the verifying instrument. This Parameter has no effect on level measurement or on volume and mass calculation, it only appears on the screen. If the value of this Parameter is not zero, „SDIST=x.xxx“ format display appears on the bottom line of the measurement screen.

### 7.3.5.6 Restart

Menu path: SERVICE / RESTART  
 Description: Restarts the instrument (Cold boot) (Reloads parameters from the non-volatile memory)

## 8. Error codes

Message on the screen	Error description	Procedure	Code
MEMORY ERROR	Memory error in the electronics	Contact the service!	1
NO INPUT SIGNAL	Probe error	Contact the service!	2
EE COM. ERROR	Hardware error (EEPROM communication error)	Contact the service!	3
MATH. OVERLOAD	Display overflow	Check the programming!	4
SIGNAL IN N.D.B.	Probe or calibration error (Signal is in near dead band)	Contact the service!	5
SIGNAL IN F.D.B.	Probe or calibration error (Signal is in far dead band)	Check the mounting specifications.	7
VMT SIZE ERROR	Linearization error: Less than two items are in the table.	Check the content of the VMT! See: 7.3.4.6.	12
VMT INPUT ERROR	Linearization table error: monotonicity error in the input (level) side of the table.	Check the content of the VMT! See: 7.3.4.6.	13
VMT OUTPUT ERROR	Linearization table error: monotonicity error in the output (volume or mass) side of the table.	Check the content of the VMT! See: 7.3.4.6.	14
VMT INPUT OV.RNG.	Linearization table error: The measured level is greater than the highest level of the table's input side.	Check the content of the VMT! See 7.3.4.6. Device performs extrapolation according to the last point pairs!	15
EE CHK ERROR	Parameter checksum error.	Check the programming! For regenerating the checksum, modify a Parameter and return to Measurement mode. If this error still remains, contact the service!	16
INTEGRITY ERROR	Parameter consistency error. (Automatically fixed internal error.) Only WARNING	Check the programming!	17
AC COM. ERROR	Hardware error	Contact the service!	18
CALIBRATION ERROR	Sensor calibration error	Contact the service!	

## 9. Menu map

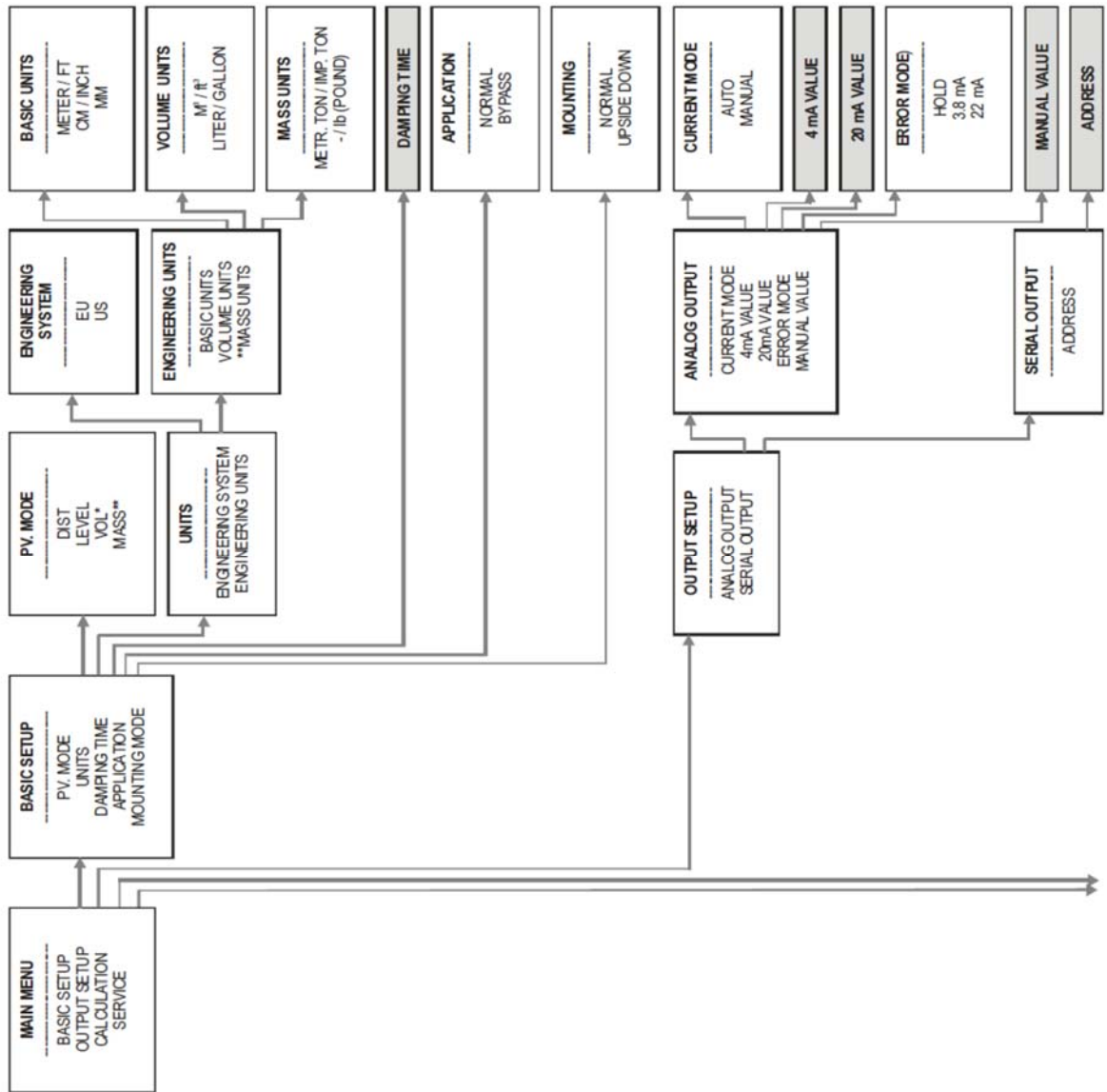

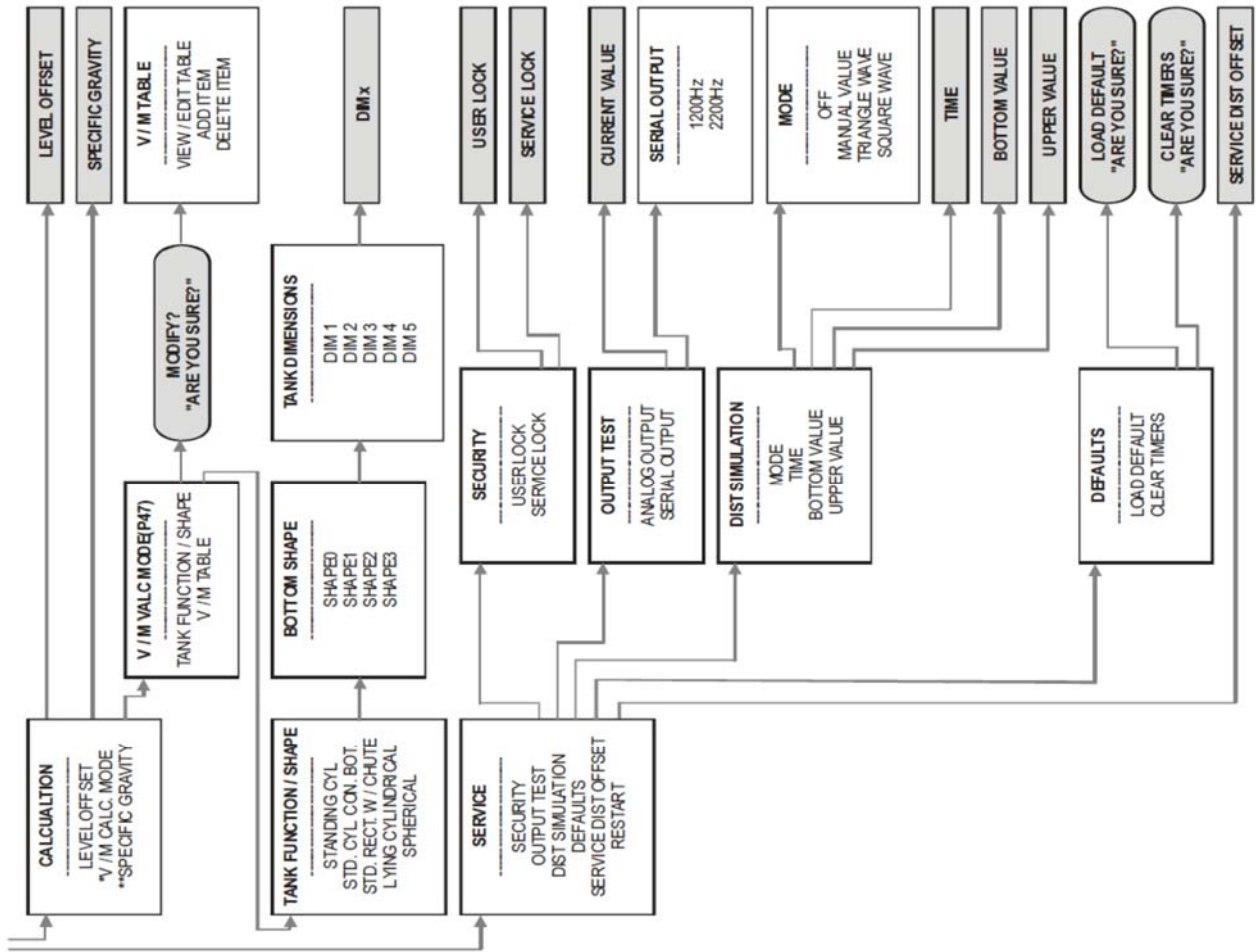

## 10. Maintenance

---

NMB units do not require maintenance on a regular basis.

Repair during or after the guarantee period should only be carried out by Kobold Messring. Devices for repair should be returned fully cleaned, and disinfected. Unused devices must be stored within the ambient temperature range specified in the technical data, and a maximum of 98% relative humidity.

## 11. Technical Information

---

Operating instructions, data sheet, approvals and further information via the QR code on the device or via [www.kobold.com](http://www.kobold.com)

## 12. Order Codes

---

Operating instructions, data sheet, approvals and further information via the QR code on the device or via [www.kobold.com](http://www.kobold.com)

## 13. Dimensions

---

Operating instructions, data sheet, approvals and further information via the QR code on the device or via [www.kobold.com](http://www.kobold.com)

## 14. Disposal

---

See “General Safety Instructions” - via the QR code on the device or via [www.kobold.com](http://www.kobold.com)

## 15. EU Declaration of Conformance

---

We, KOBOLD Messring GmbH, Nordring 22-24, 65719 Hofheim, Germany, declare under our sole responsibility that the product:

**Magnetostrictive Level Transmitters**

**Model: NMB**

to which this declaration relates is in conformity with the following EU directives stated below:

**2014/30/EU**

**EMC Directive**

**2011/65/EU**

**RoHS (category 9)**

**2015/863/EU**

**Delegated Directive (RoHS III)**

Also, the following standards are fulfilled:

**EN 61326-1:2013** Electrical equipment for measurement, control and laboratory use - EMC requirements - Part 1: General requirements

**EN 61326-2-3:2013** Electrical equipment for measurement, control and laboratory use - EMC requirements - Part 2-3: Particular requirements - Test configuration, operational conditions and performance criteria for transducers with integrated or remote signal conditioning

**EN IEC 63000:2018** Technical documentation for the assessment of electrical and electronic products with respect to the restriction of hazardous substances

Hofheim, 05 Jan. 2024



H. Volz  
General Manager



J. Burke  
Compliance Manager

## 16. EU Declaration of Conformity (ATEX)

---

We, Kobold Messring GmbH, Nordring 22-24, 65719 Hofheim, Germany, hereby declare under our sole responsibility and with the aim of traceability that the product

**Magnetostrictive Level Transmitters**                      **Model: NMB-...**

EU type examination certificate:    **BKI24ATEX0022 X**

Complies with all relevant requirements of the following directive(s):

**2014/34/EU**    Equipment and Protective systems intended for use in potentially Explosive Atmospheres

The following harmonized standards were applied for conformity assessment:

<b>EN IEC 60079-0:2018</b>	Equipment – General requirements
<b>EN 60079-1:2015</b>	Device protection through flameproof enclosure “d”
<b>EN 60079-11:2012</b>	Device protection through intrinsic safety “i”

The above-mentioned product complies with Directive 2014/34/EU. New editions may have already replaced one or more of the standards mentioned in the EU type examination certificates. Kobold Messring declares that the product mentioned in this declaration of conformity either meets the requirements of the new editions or is not affected by the changes.

The notified body DEKRA Testing and Certification GmbH, identification number: 0158, was activated, in accordance with Article 17 of Directive 2014/34/EU, to monitor quality assurance related to the production process.

Certificate:    **BVS 24 ATEX ZQS/E110**

Hofheim, 09 Dec. 2024



H. Volz  
General Manager

J. Burke  
Compliance Manager

## 17. ATEX certificate



**EXVA**  
Vizsgáló és Tanúsító Kft.

A NAH által NAH-6-0027/2022/K számon  
akkreditált terméktanúsító szervezet. /  
Product certification organisation accredited  
by NAH under No. NAH-6-0027/2022/K



(1) *EU-Típus Vizsgálati Tanúsítvány*  
*EU-Type Examination Certificate*

(2) A potenciálisan robbanásveszélyes környezetben történő alkalmazásra szánt  
berendezések, védelmi rendszerek  
2014/34/EU Direktiva /

Equipment or Protective Systems Intended for use  
in Potentially Explosive Atmospheres  
Directive 2014/34/EU

(3) EU-Típus Vizsgálati Tanúsítvány száma /  
EU-Type Examination Certificate Number: **BKI24ATEX0022 X**

(4) A gyártmány / Product:  
**Magnetrostrikiós szinttávadó család /  
Magnetostrictive level transmitter family**

Típusa / Type:  
**NMB**

(5) Gyártó / Manufacturer:  
**Kobold Messring GmbH**

(6) Cím / Address:  
**Nordring 22-24  
65719 Hofheim am Taunus  
Germany**

(7) A gyártmány és annak változatai a jelen tanúsítvány vonatkozó pontjában vannak feltüntetve. /  
This product and any acceptable variation thereto is specified in the schedule to this certificate and the  
documents therein referred to.

(8) A ExVA Vizsgáló és Tanúsító Kft., 1418 sz. kijelölt testület, a 2014. február 26-i Európai Parlament és Tanács  
2014/34/EU Direktívájának 17. cikkelye szerint tanúsítja, hogy a gyártmány megfelel az Alapvető  
Egészségügyi és Biztonsági Követelményeknek a Direktíva II. számú Mellékletében a potenciálisan  
robbanásveszélyes térben alkalmazásra szánt gyártmányok tervezése és gyártása szerint. /  
ExVA Testing and Certification Limited Liability Company, notified body number 1418 in accordance with  
Article 17 of Directive 2014/34/EU of the European Parliament and of the Council, dated 26 February 2014,  
certifies that this product has been found to comply with the Essential Health and Safety Requirements relating  
to the design and construction of products intended for use in potentially explosive atmospheres given in Annex  
II to the Directive.

A vizsgálat eredményeit az alábbi nyilvántartási számú bizalmas vizsgálati dokumentáció  
tartalmazza: /  
The examination and test results are recorded in confidential report No.:

**VA-0283-24-A**

Ez a tanúsítvány csak a maga egészében és változatlan formában használható fel, mellékleteivel együtt. /  
This certificate may only be reproduced in its entirety and without any changes, schedule included.

Lapszám / Page: 1/7



Tanúsítási eljárás 13. melléklete

Rev00. 2023.02.01.





**BKI24ATEX0022 X**  
**EU-Típus Vizsgálati Tanúsítvány/**  
**EU-Type Examination Certificate**

- (9) Az alapvető egészségügyi és biztonsági követelményeknek való megfelelést a következők biztosítják: /  
 Compliance with the Essential Health and Safety Requirements has been assured by compliance with:  
**EN IEC 60079-0:2018,**  
**EN 60079-1:2015,**  
**EN 60079-11:2012**

kivéve a 18. pontban felsorolt követelményekre vonatkozóan.  
 except in respect of those requirements listed at item 18 of the Schedule.

- (10) A tanúsítvány száma után álló „X” jel azt mutatja, hogy a gyártmány speciális feltételek megtartása mellett felel meg a jelen tanúsítvány vonatkozó pontjában feltüntetett biztonságos alkalmazás feltételeinek. /  
 If the sign „X” is placed after the certificate number, it indicates that the product is subject to Specific Conditions of Use specified in the schedule to this certificate.
- (11) Jelen EU-TÍPUS VIZSGÁLATI TANÚSÍTVÁNY csak a megjelölt gyártmány tervezésére és kivitelezésére vonatkozik. A jelen Direktiva további követelményei vonatkoznak a gyártmány gyártási folyamatára és szállítására. Ezek nem tartoznak e tanúsítvány alá. /  
 This EU-TYPE EXAMINATION CERTIFICATE relates only to the design and construction of the specified product. Further requirements of this Directive apply to the manufacturing process and supply of this product. These are not covered by this certificate.
- (12) A gyártmány jele a következő /  
 The marking of the product shall include the following:

**II 1 G Ex ia IIB T6.....T5 Ga**  
**II 2 G Ex db IIB T6.....T5 Gb**  
**II 1/2 G Ex db ia IIB T6.....T5 Ga/Gb**

Környezeti hőmérséklet / Ambient temperature:

**Tkörny/amb = lásd / see 15.4**

**ExVA Vizsgáló és Tanúsító Kft.**  
**ExVA Testing and Certification Ltd.**  
 Hungary, 1037 Budapest, Mikoviny u. 2-4.  
 Tel.: +36 1 408 2213  
 E-mail: office@exva.hu

**ExVA Vizsgáló és Tanúsító Kft.**  
 1037 Budapest, Mikoviny S. u. 2-4  
 10925306-2-41

**Nagy Botond**  
 Tanúsító Szervezet Vezető /  
 Head of Certification Body

**Budapest, 2024.12.02.**

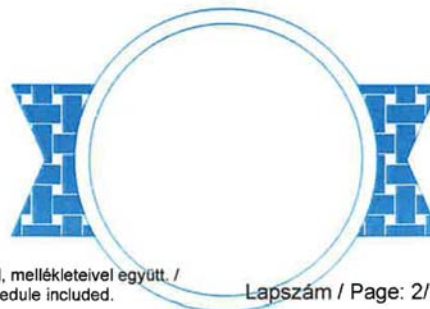

Ez a tanúsítvány csak a maga egészében és változatlan formában használható fel, mellékleteivel együtt. /  
 This certificate may only be reproduced in its entirety and without any change, schedule included.

Lapszám / Page: 2/7





BKI24ATEX0022 X  
 EU-Típus Vizsgálati Tanúsítvány/  
 EU-Type Examination Certificate

**(13) Melléklet / Schedule**

**(14) EU-TÍPUSVIZSGÁLATI TANÚSÍTVÁNY szám /  
 EU-TYPE EXAMINATION CERTIFICATE N<sup>o</sup>  
 BKI24ATEX0022 X**

**(15) Gyártmány leírása / Description of Product**

Az NMB típusú szinttávadók úszós szintmérővel rendelkező többfunkciós gyártmányok, mérik a folyadék szintjét, határszintjét és a hőmérsékletét. Kimenőjelük 4...20 mA analóg áramjel és/vagy digitális jel HART adatátvitellel.

A távadó festett, öntött alumínium vagy rozsdamentes acél tokozásában van benne a kiöntött elektronikus egység. Opcióként LCD kijelző modullal ellátható, ekkor a fedélben üvegablak van.

Az érzékelő védőcsőve rozsdamentes acél, mely rendelkezhet PFA műanyag bevonattal.

Az úszó anyaga : rozsdamentes acél, vagy a NMB-E, NMB-G változatoknál PVDF ill. PP műanyag. /

The NMB transmitters are multifunction apparatus with float level meter, they measure the liquid level, interface level and temperature of liquid. Their output signal is 4...20 mA analogue current and/or digital with HART communication.

The enclosure of transmitter is painted cast aluminium alloy or stainless steel, in this are cast electronics, optionally is LCD display module, on the cover is glass light-transmitting part.

The material of float and probe of sensor are stainless steel, which can be provided with PFA plastic coating.

The material of floating body : stainless steel, or at the NMB-E, NMB-G versions plastics PVDF resp. PP.

Ez a tanúsítvány csak a maga egészében és változatlan formában használható fel, mellékleteivel együtt. /  
 This certificate may only be reproduced in its entirety and without any change, schedule included.

Lapszám / Page: 3/7



Tanúsítási eljárás 13. melléklete

Rev00, 2023.02.01.





BKI24ATEX0022 X  
EU-Típus Vizsgálati Tanúsítvány/  
EU-Type Examination Certificate

(15.1) Típusjel magyarázat / Type code explanation

NMB- □ □ □ □ □ □ □ □ □ □

Úszó opciók / Options float	0 1...9 vagy/or A...Z (nem Ex releváns / not Ex relevant)
Kimenet / Output	5 6 7 8 9 A B C D
Szonda hossz / Probe length	0...9 vagy/or A..Z, 0..9 „Ex db”, „Ex db ia” : 0 m... 10 m „Ex ia” : 0 m..18 m
Ház / Housing	A=Aluminium, ház pozíció / housing position „A”  L=Aluminium, ház pozíció / housing position „B”  E=Rozsdamentes/St steel, ház pozíció / housing position „A”  G=Rozsdamentes/St steel, ház pozíció / housing position „B”
Szonda típus/technológiai csatlakozás / Probe type/process connection	A..Z vagy/or 0..9, A..Z vagy/or 0..9, A..Z vagy/or 0..9, A..Z vagy/or 0..9
Tervezés / Design	T B E G M C V W D J N O
Alap model / Base model Magnetosztatikus szinttávadó / Magnetostrictive level transmitter	NMB-

Ez a tanúsítvány csak a maga egészében és változtatlan formában használható fel, mellékleteivel együtt. /  
This certificate may only be reproduced in its entirety and without any change, schedule included.

Lapszám / Page: 4/7



Tanúsítási eljárás 13. melléklete

Rev00. 2023.02.01.





BKI24ATEX0022 X  
EU-Típus Vizsgáló Tanúsítvány/  
EU-Type Examination Certificate



(15.2) Műszaki leírás / Technical description

TÍPUS / TYPE	MÉREV MÉRŐCSŐVES MINI VÁLTOZAT / MINI VERSION WITH RIGID PROBE	MÉREV MÉRŐCSŐVES VÁLTOZAT / RIGID PROBE VERSION	HAJLÉKONY MÉRŐCSŐVES VÁLTOZAT / FLEXIBLE PROBE VERSION	MÉREV MÉRŐCSŐVES MŰANYAG BEVONATOS VÁLTOZAT / PLASTIC COATED RIGID PROBE VERSION
Mért változók / Measured process values	Folyadék szint, távolság, térfogat / Liquid level, distance, volume			
Szonda névleges hossza / Nominal probe length	0,3 m ... 1,5 m	0,3 m ... 4,5 m	2 m ... 15 m	0,3 m ... 3 m
Mérőcső anyaga / Material of the probe	Rozsdamentes acél / Stainless steel: DIN 1.4571			PFA bevonatú rozsdamentes acél / PFA coated stainless steel
Max. közegnyomás / Max. process pressure	1 MPa (10 bar)	2,5 MPa (25 bar)	1,6 MPa (16 bar)	0,3 MPa (3 bar)
Közeghőmérséklet / Process temperature	-40 °C ... +90 °C lásd hőmérsékleti diagram / see temperature diagram			
Úszó méret (anyag) / Float size (material)	Henger / Cylinder: Ø 28 x 28 mm (1.4404)	Henger / Cylinder: Ø 49 x 60 mm (Ti); Ø 50 x 100 mm (Ti); Ø 53,5 x 60 mm (1.4404/Ti) Gömb / Sphere: Ø 96 mm (1.4435); Ø 124 mm (1.4401)		Henger / Cylinder: Ø 76 x 87 mm (PVDF/PP)
Közeggel érintkező anyagok / Material of wetted parts	Rozsdamentes acél / Stainless steel: DIN 1.4571			PFA + PVDF
Környezeti hőmérséklet / Ambient temperature	-40 °C ... +70 °C lásd hőmérsékleti diagram / see temperature diagram (Kijelző esetén minimális hőmérséklet -25 °C / In the case of display, the minimum temperature is -25 °C)			
Analog Kimenet / Analog Output	4...20 mA (határértékek / limit values: 3,9 ... 20,5 mA)			
Soros komm. Kimenet / Serial comm. Output	HART (minimális hurokellenállás / minimum loop resistance: 250 Ω)			
Kijelző Kimenet / Display Output	NRM-300P Grafikus kijelző / Graphic display			
Kimenőjel beállási idő / Damping time	Állítható / Adjustable: 0...99 sec			
Hibajelzés / Error indication	Kimenőjel / Output signal = 22 mA vagy / or 3,8 mA			
Kimenet terhelhetősége / Output load	Rt = (Ut-12,5V) / 0,02 A, Ut = tápegység feszültsége / power supply voltage			
Távadó tápfeszültség / Power supply of the transmitter	12,5 V ... 36 V DC			
Elektromos védelem / Electrical protection	III. érintésvédelmi osztály / III. contact protection class			
IP Védelem / IP Protection	IP 67			
Technológiai csatlakozás / Process connection	NMB-xxxxxxx9x : IP68 (4 m / 4 óra/hour)			
Villamos csatlakozás / Electrical connection	Rendelési kód szerint / According to order code			
Elektronika ház / Housing	Villamos csatlakozás M20 x1,5 tömszelencén keresztül / Electrical connection via M20 x1.5 cable gland, kábel külső átmérő / cable outer diameter: Ø 6 ... Ø12 mm, huzalkeresztmetszet / wire cross-section: max. 1,5 mm <sup>2</sup>			
Tömeg / Mass	Festett alumínium / Painted aluminum			
	1,7 kg + mérőcső / measuring tube: 0,25 kg/m	1,7 kg + mérőcső / measuring tube: 0,6 kg/m	2,9 kg + húzóerő / tensile weight 3,5 kg + mérőcső / measuring tube: 0,3 kg/m	1,7 kg + mérőcső / measuring tube: 0,7 kg/m

Ez a tanúsítvány csak a maga egészében és változatlan formában használható fel, mellékleteivel együtt. / This certificate may only be reproduced in its entirety and without any change, schedule included.

Lapszám / Page: 5/7



Tanúsítási eljárás 13. melléklete

Rev00. 2023.02.01.





BKI24ATEX0022 X  
EU-Típus Vizsgálati Tanúsítvány/  
EU-Type Examination Certificate

(15.3) Robbanásbiztonságot érintő műszaki leírás /  
Technical description concerning explosion safety

TÍPUS KÓD / TYPE	NMB-xxxxxxx5x NMB-xxxxxxx6x NMB-xxxxxxx7x NMB-xxxxxxx8x	NMB-xxxxxxxCx NMB-xxxxxxxDx	NMB-xxxxxxxAx NMB-xxxxxxxBx	NMB-xxxxxxx9x
Védelmi Jel (ATEX) / Ex marking (ATEX)	Ⓔ II 1 G Ex ia IIB T6...T5 Ga 0 ... 18 m	Ⓔ II 1/2 G Ex db ia IIB T6...T5 Ga/Gb 0 ... 10 m	Ⓔ II 2 G Ex db IIB T6...T5 Gb 0 ... 10 m	Ⓔ II 1 G Ex ia IIB T6...T5 Ga 0 ... 18 m
Védelmi Jel (IECEx) / Ex marking (IECEx)	Ex ia IIB T6...T5 Ga 0 ... 18 m	Ex db ia IIB T6...T5 Ga/Gb 0 ... 10 m	Ex db IIB T6...T5 Gb 0 ... 10 m	-
Kábel bevezető / Cable entry	M20 x1,5 tömszelence / cable gland	M20 x1,5 Tanúsított „Ex d” fém tömszelence / Certified „Ex d” metal cable gland		-
Kábel külső átmérő / Cable outer diameter	Ø 7 ... 13 mm	Ø 9 ... 11 mm		-
Ex táp- és jeláramkör adatok / Ex power supply, intrinsically safety data	Ui = 30 V, Ii = 140 mA, Pi = 1 W, Ci ≤ 15 nF, Li ≤ 200 µH		Ui: 12,5 V DC...36 V DC	Ui = 30 V, Ii = 140 mA, Pi = 1 W, Ci ≤ 25 nF, Li ≤ 210 µH
Megjegyzés / Comment:	Az „NMB-xxxx5xx9x” típusú készülék IP68-as védettségű. A fedél, a tömszelence, a kábel és a záródugó be van ragasztva és nem nyitható!!! / The NMB-xxxx5xx9x type instrument is IP68-rated. The cover, cable gland, cable and the plug are glued and cannot be opened!			

(15.4) Hőmérsékleti határadatok / Temperature limits

Készülék mérőcső változata / Device measuring tube version	Hőmérsékleti osztály / Temperature class	Környezeti hőmérséklet * / Ambient temperature *	Közeghőmérséklet / Medium temperature
Merev cső (rúd) / Rigid tube (rod)	T6	-40 °C...+70 °C	+80 °C
Hajlékony cső (kötél) / Flexible tube (rope)			+70 °C
Merev cső (rúd) / Rigid tube (rod)	T5	-40 °C...+55 °C	+90 °C
Megjegyzés / Comment:	* kijelzővel szerelt típusok esetén a környezeti hőmérséklet alsó értéke -25 °C-ra korlátozódik / * In the case of models equipped with display, the lower ambient temperature is limited to -25 °C		

(16) Jegyzőkönyv / Report N°

Ez a tanúsítvány csak a maga egészében és változtatlan formában használható fel, mellékleteivel együtt. /  
This certificate may only be reproduced in its entirety and without any change, schedule included.

Lapszám / Page: 6/7



Tanúsítási eljárás 13. melléklete



Rev00. 2023.02.01.





BKI24ATEX0022 X  
EU-Típus Vizsgálati Tanúsítvány/  
EU-Type Examination Certificate

**(17) Biztonságos üzemeltetés feltételei / Special conditions of Use**

A  II 1 G Ex ia IIB T6...T5 Ga védelmi jelű berendezések alumínium-öntvény tokozatú változatánál a tokozat alumínium-tartalma a határértéket túllépi, ezért a berendezéseket védeni kell ütési illetve súrlódási hatások ellen. / In case of  II 1 G Ex ia IIB T6...T5 Ga protected equipment version with aluminium alloy enclosure, the aluminum-content of enclosure exceeds the limit, thus the equipment must be protected against impact and friction effects.

**(18) Alapvető egészségügyi és biztonsági követelmények / Essential Health and Safety Requirements**

Amellett, hogy az alapvető egészségügyi és biztonsági követelményeknek való megfelelést a 9. pontban felsorolt szabványok biztosítják, a következő megfontolások vonatkoznak a gyártmányra, melyek megfelelése jegyzőkönyvben bizonyított: / In addition to the Essential Health and Safety Requirements (EHSRs) covered by the standards listed at item 9, the following are considered relevant to this product, and conformity is demonstrated in the report:

Záradék / Clause	Tárgy / Subject
Nem vonatkozik / Not applicable	Nem vonatkozik / Not applicable

**(19) Rajzok és dokumentációk / Drawings and Documents**

GYÁRTÓI DOKUMENTÁCIÓK / MANUFACTURER'S DOCUMENTS						
No.	Fájl név / File name	Szám / Number	Lap / Sheet	Verzió / Issue	Dátum / Date	Leírás / Description
1.	n2gbm_nmb_K02_1124.pdf	NMB K02/1124	30	-	2024.11.11	Működési leírás / Operating instructions
2.	MBA5_Ex_data_plate_Kobold_eng_II.pdf	003.595	1	-	2024.04.02	Adattábla / Data label
3.	NMB_LoC.pdf	MT-500-041124	1	-	2024.11.04	Beleegyező levél / Letter of Consent
4.	NMB_Model-Code.pdf	-	1	-	2024.11.13	Model kód kereszt referencia / Model-Code Cross-reference

ExVA Vizsgáló és Tanúsító Kft.  
1037 Budapest, Mikoviny S. u. 2-4  
10925306-2-41

  
**Nagy Botond**  
Tanúsító Szervezet Vezető /  
Head of Certification Body

Ez a tanúsítvány csak a maga egészében és változatlan formában használható fel, mellékleteivel együtt. / This certificate may only be reproduced in its entirety and without any change, schedule included.

Lapszám / Page: 7/7



Tanúsítási eljárás 13. melléklete

Rev00. 2023.02.01.

