

**Operating Instructions
for
Level Switch
Tuning Fork Principal**

Model: NWS



1. Contents

1. Contents.....	2
2. Note	3
3. Instrument Inspection.....	3
4. Regulation Use	4
5. Operating Principle.....	4
6. Use in Hazardous Areas (NWS-2E)	4
6.1 Device function	4
6.2 Commissioning/Installation	5
6.3 Designation.....	5
6.4 Temperature resistance	6
7. Mechanical Connection.....	6
8. Electrical Connection	7
8.1 NWS-...200	7
8.2 NWS-...23/24; NWS-...2E (ATEX certification).....	9
9. Settings.....	10
9.1 Settings for NWS-...200.....	10
9.2 Settings for NWS-...23/24 and NWS-2E	12
10. Service and Maintenance.....	15
11. Trouble Shooting.....	15
12. Recommended Spare Parts.....	15
13. Technical Information.....	16
14. Order Codes	16
15. Dimensions	16
16. Disposal	17
17. EU Declaration of Conformance (ATEX).....	18
18. EU Declaration of Conformance	19
19. UK Declaration of Conformity.....	21
20. EU-Type Examination certificate	23
21. IECEx Certificate.....	26

Manufactured and sold by:

Kobold Messring GmbH
Nordring 22-24
D-65719 Hofheim/Germany
Tel.: +49(0)6192-2990
Fax: +49(0)6192-23398
E-mail: info.de@kobold.com
Internet: www.kobold.com

2. Note

Please read these operating instructions before unpacking and putting the unit into operation. Follow the instructions precisely as described herein.

The instruction manuals on our website www.kobold.com are always for currently manufactured version of our products. Due to technical changes, the instruction manuals available online may not always correspond to the product version you have purchased. If you need an instruction manual that corresponds to the purchased product version, you can request it from us free of charge by email (info.de@kobold.com) in PDF format, specifying the relevant invoice number and serial number. If you wish, the operating instructions can also be sent to you by post in paper form against an applicable postage fee.

Operating instructions, data sheet, approvals and further information via the QR code on the device or via www.kobold.com

The devices are only to be used, maintained and serviced by persons familiar with these operating instructions and in accordance with local regulations applying to Health & Safety and prevention of accidents.

When used in machines, the measuring unit should be used only when the machines fulfil the EC-machine guidelines.

3. Instrument Inspection

Instruments are inspected before shipping and sent out in perfect condition.

Should damage to a device be visible, we recommend a thorough inspection of the delivery packaging. In case of damage, please inform your parcel service / forwarding agent immediately, since they are responsible for damages during transit.

Scope of delivery:

The standard delivery includes:

- Level Switch model: NWS

4. Regulation Use

Kobold model NWS Liquid-Level Switches are designed to be wired as 2-wire or 3-wire switches and can be universally installed in any position in containers and piping. They can be used in many types of liquids including oils, water, paints and varnishes, sauces, milk, carbonated liquids and foamy oils. The liquid may have a maximum viscosity of 5000 cSt. At higher viscosities, the response time may increase. NWS Liquid-Level Switches are ideally suited for use in hygienic and sterile applications and designed to withstand CIP cleaning methods at temperatures up to 150 °C.

Any use of the device which exceeds the manufacturer's specification may invalidate its warranty. Therefore, any resulting damage is not the responsibility of the manufacturer. The user assumes all risk for such usage.

5. Operating Principle

The KOBOLD liquid level switch NWS is designed as a 2 and 3-wire switch and can be universally used in vessels and pipelines. The NWS operates on the tuning fork principle in air at resonance frequency. A piezoelectric crystal is used for excitation of oscillations and for monitoring the actual oscillation frequency. When the fork is immersed in liquid, the frequency changes: this change is detected electronically and the output signal is changed. The NWS operates as a two-wire switch in series with the load. The simple electronic switch is operated by the liquid. The NWS can also be connected to a PLC through a third terminal.

Special Features:

The NWS has a switch status indicator with LED, which can be seen continuously through a lens in the cover. The LED flashes approximately once every second, when the NWS has switched off and goes onto a permanent light, when the NWS is switched on. The LED is a visible confirmation that the NWS is working correctly and that the condition of the wet side is correctly indicated. With a selector switch the NWS can be set either as an upper limiter or as a lower limiter.

6. Use in Hazardous Areas (NWS-2E)

6.1 Device function

The intrinsically safe NAMUR oscillating fork sensor is used to detect the fill levels of combustible and non-combustible liquids. The sensor is supplied with current from a switching amplifier with an intrinsically safe output circuit in accordance with the NAMUR specification and behaves accordingly when the oscillating fork is dampened by liquid or can oscillate freely. The sensor can be used in all zones in gaseous hazardous areas.

6.2 Commissioning/Installation

- The devices may be installed in zones 0, 1 and 2. The intrinsically safe circuits must be installed (by specialists) in conformance with the applicable installation requirements (certification document of installer, protected routing of the intrinsically safe circuits, etc.).
- The devices are constructed in accordance with protection type IP 65. If applicable, they must be protected against adverse environmental conditions.
- The EU model test certificates must be complied with. Any “special regulations” contained in them must be followed.
- The device should only be used for its intended use.
- The connection with the associated and/or intrinsically safe equipment must be separately checked.
- The sensors must be grounded to discharge accumulated electrostatic charge.
- At an ambient temperature area of - 5 .. + 70 °C the connected electrical cable may be mechanically moved. Furthermore at an ambient temperature area of - 20 .. + 70 °C the electrical cable must be mounted in a fixed and static manner.
- The tuning fork should be protected against external hits.
- The connection area of the plug connection version and the connection cable should be protected against electrostatic charges during its use in zone 0.
- The sensors are by default produced with 1.5 m long cable or with a plug. In this case a Ci of 8 pF should be taken into account, the internal inductance is negligible.
 - For longer cable length an additional Lc value of 0.14 nF m⁻¹ and LI value of 0,65 µH m⁻¹ per each meter of supplied cable should be considered.

6.3 Designation

Model: NWS***2E* ****

 II 1 G Ex ia IIC T6 Ga

BVS 03 ATEX E 119

IECEX BVS 13.0004

Identification number: 0158

Production-No.: SN: E999999 (consecutively numbered)

6.4 Temperature resistance

The values for ambient temperatures ranging from -20 °C up to the values indicated in the following table apply to this sensor, depending on the max. temperature of the oscillating forks in the sensor:

Ambient temperature	70 °C	70 °C
Medium temperature	75 °C	90 °C
Temperature class	T6	T5

7. Mechanical Connection

During installation and removal, recognised and applicable engineering practices and regulations shall be observed. When working on electrical and pneumatic plants, the special safety requirements shall be observed.

The NWS switch can be installed in containers or piping by screwing it into a threaded mounting flange or other type of mounting device. The threaded connection must be sealed with Teflon (PTFE) tape. Be sure to turn the switch at the hexagonal drive; do not install the switch by turning it at the housing.

After installation, the NWS-...200 can be rotated up to 330° to locate the M16 cable connection (supplied with the device) in a suitable position.

If the switch is installed in a horizontal position, the tuning fork gap should be positioned vertically so that the liquid can drain from it. If the liquid being monitored is of high viscosity, the switch should be installed so that it extends the maximum distance into the container or piping in order to prevent the thick liquid from sticking and accumulating between the fork and the container or pipe wall. If the switch is installed in piping, the tuning fork gap should be positioned so that it is parallel to the pipe axis.

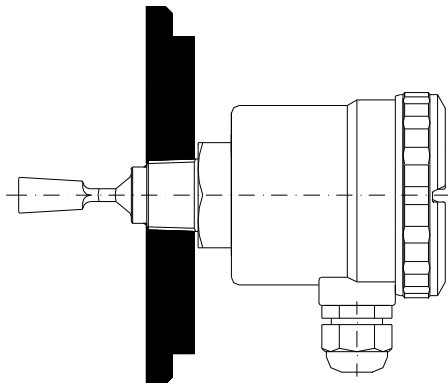

8. Electrical Connection



Attention! Be sure that the supply voltage of your system is the same as that specified on the device nameplate. Make sure that the electrical supply lines are de-energised when connecting the device!

8.1 NWS-...200

Series wiring with a 2-wire connection

Please note:

- The switch must always be operated in series with a load.
- The switch must be grounded at terminal 1.
- The switch draws a continuous operating current of less than 3.5 mA (even when it is "off"). For this reason, it cannot be used for loads that do not allow an "off" current (such as for gas discharge lamps).
- The maximum load current for the switch is 500 mA. The user must provide suitable protective measures to ensure that this load limit is not exceeded.

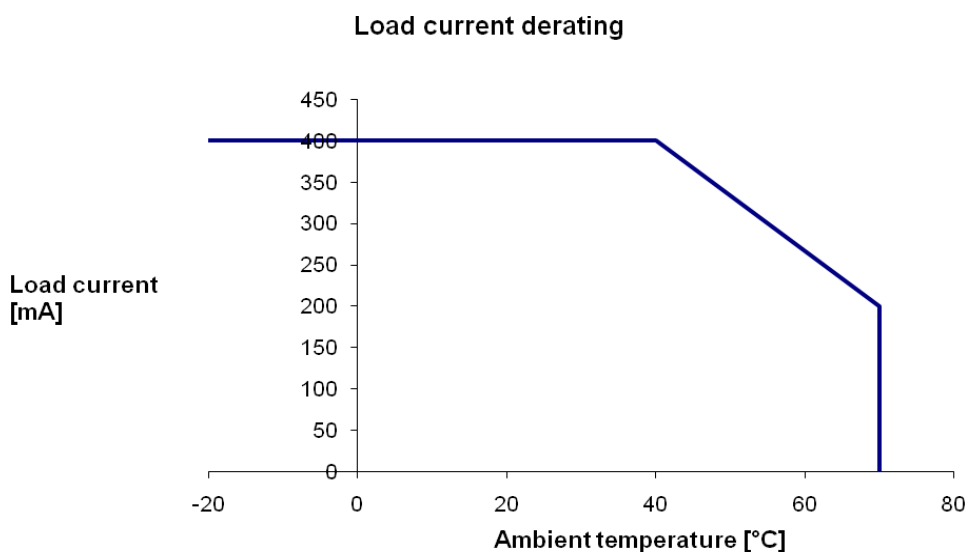

Wiring diagram: 2-wire 24-240V_{AC/DC}, series load, $I_{max} \leq 400\text{mA}$



PLC connection with 3-wire connection

Please note:

- An integral series resistance is used in the 3-wire circuit to generate a PLC-compliant voltage signal.
- The signal can be picked up at terminal 4.
- PLC programming devices or computers from various manufacturers will have different "OFF" threshold voltages. If you should have problems with this setting, please contact us for assistance.

Wiring diagram: 3-wire, $V_S = 24\text{V}_{DC}$, output PNP: $U_{HIGH} \sim 20\text{V}$; $U_{LOW} \sim 3.5\text{V}$; $I_{max} \leq 400\text{mA}$

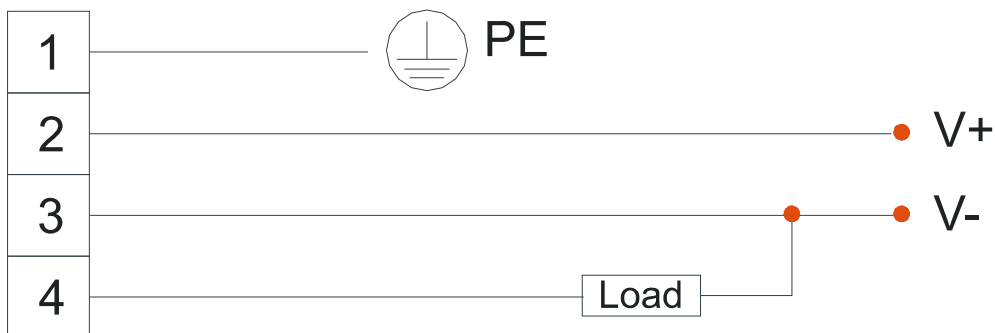

8.2 NWS-...23/24; NWS-...2E (ATEX certification)

- Make sure that the electrical supply lines are de-energised.
- Connect the device using the M12x1 plug or a connection cable as shown in the wiring diagram below.
- Matching connectors with different cable lengths are optionally available.
- Make sure that the installation is properly performed and that the IP protection level is maintained.

Wiring diagram NWS-...23/24 (3-wire, 24 V_{DC})

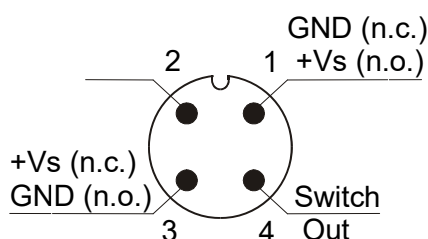

Cable pin assignment

Colour of core	NWS-...23/24
brown	+Vs(n.o.) / GND
blue	GND / +Vs (n.c.)
black	Switch Out

Wiring diagram NWS-2ES.. (NAMUR, ATEX, 2-wire, 8.2 V_{DC})

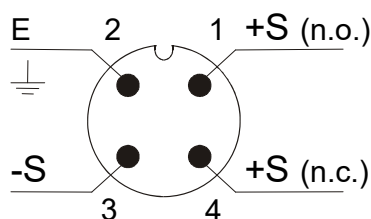

Lead-/Pinnumber	NWS-...2EF
1	+S (n.o.)
2	ground
3	-S
4	+S (n.c.)

Wiring examples NWS-...2E... with Power supply unit acc. to IEC 60947-5-6

Plug M12x1

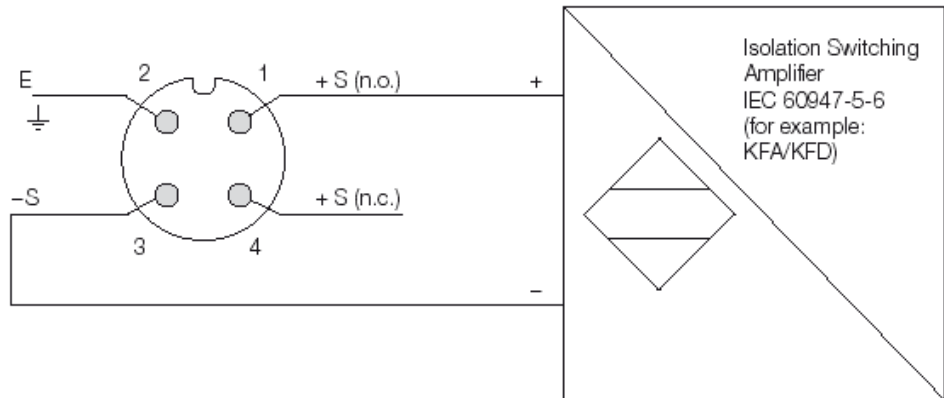

Cable 1.5 m

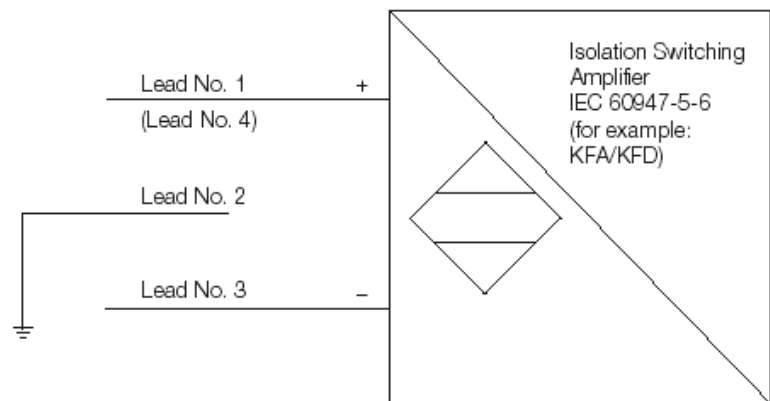

9. Settings

9.1 Settings for NWS-...200..

9.1.1 Signalling the operating status

The NWS has an output status indicator with an LED monitor that can be viewed continuously through a lense in the cover. The LED flashes approximately once every second when the NWS is off. It is continuously illuminated when the NWS is switched on. The LED provides visual confirmation that the NWS is operating correctly and that the status of the wet side is correctly displayed. With its operating mode switch, the NWS can be set to operate as either an N/C contact or an N/O contact.

9.1.2 Operating mode selector switch

The operating mode switch is positioned on the circuit board on the right about the LED. If the switch is operated as an N/C contact (upper limiter), the operating mode must be set to DRY-ON, in order to obtain the maximum fail-safe behaviour. The device completes the circuit in the dry state (empty state) so that a fault at the device or in the wiring results in a voltage drop that causes an alarm to be triggered (break circuit). Conversely, if the switch is to WET-ON, the device operates as an N/O contact (lower limiter) in fail-safe mode, in which case the fork is normally immersed in liquid.

9.1.3 Calibration mode

Each appliance is adjusted by the factory to record fluids with density 1,0 kg/l (water). It is not usually necessary to alter this pre-adjustment. In extreme situations, however, such as with very light fluids at high temperatures or highly viscous fluids, which produce a significantly extended reaction time from dry to wet, it can be advantageous to alter the pre-adjustment. In order to attain the calibration mode the Setup button must be activated and held, then the supply voltage must be switched on. After approximately 1 second the LED goes on, after 2 seconds the LED goes out, then let go of the Setup button – the appliance stays now in the main menu of the calibration mode.

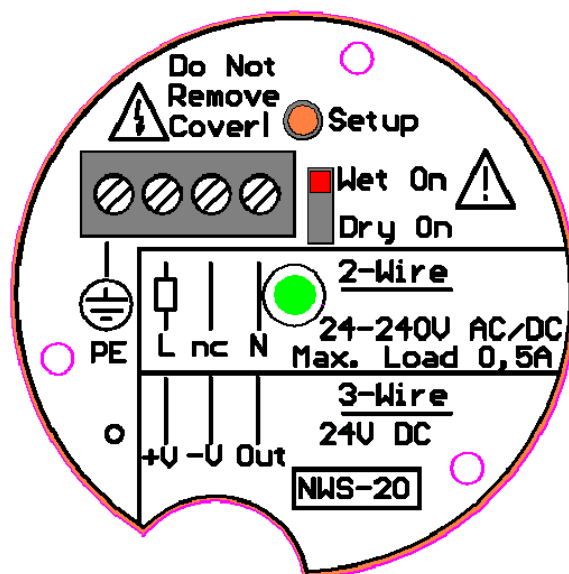

There is a choice of options in the main menu - Switchpoint Calibration, Hysteresis Level and LED Mode. The LED indicates the selected option:

- Switchpoint Calibration: LED flashes briefly 1x, then LED 2 seconds off.
- Hysteresis Level: LED flashes briefly 2x, then LED 2 seconds off.
- LED Mode: LED flashes briefly 3x, then LED 2 seconds off.

The option points are repeated in an infinite loop.

In order to get access to an option the Setup button must be activated briefly when the LED has signalled the requested option point.

Switchpoint Calibration:

The "Switchpoint Calibration Mode" is signalled by: LED 1x briefly off, then LED 2 seconds on.

Dip the tuning fork as far as the required switchpoint (1/2 – 2/3 of the fork length) in the medium and activate the Setup button. The calibration is made.

A successful calibration is signalled by the LED flashing quickly three times. Hysteresis and LED Mode are set back to default! After calibration the switch back to the main menu takes place.

Hysteresis Level:

The "Hysteresis Level Mode" is signalled by: LED 2x briefly off, then LED 2 seconds on. Briefly activate the Setup button to get to the submenu.

- Hysteresis Level 1 (approx. 1-1.5mm): LED flashes briefly 1x, then LED 2 seconds off.
- Hysteresis Level 2 (approx. 3-4.5mm, Standard): LED flashes briefly 2x, then LED 2 seconds off.
- Hysteresis Level 3 (approx. 5-7.5mm): LED flashes briefly 3x, then LED 2 seconds off.

The choice of options is repeated in an infinite loop. To select an Hysteresis Level, the Setup button must be activated after the flashing of the relevant LED. Three quick flashes of the LED signal that an option has been selected, then the switch back to the main menu is made.

LED Mode:

The "LED Mode" is signalled by: LED briefly 3x off, then LED 2 seconds on. Briefly activate the Setup button in order to attain the option menu LED Mode.

- LED Mode 1 (Standard): LED flashes briefly 1x, then LED 2 seconds off. LED shows the status of the switch output
- LED Mode 2: LED flashes briefly 2x, then LED 2 seconds off. LED indicates whether the tuning fork is wetted or not

The choice of options is repeated in an infinite loop. In order to select an "LED Mode" the button must be briefly activated after the relevant flashing of the LED. Three quick flashes of the LED signal that an option has been selected. When the LED Mode has been successfully selected, the switch back to the main menu is made.

In order to leave the calibration mode, the appliance must be separated from the voltage supply for approx. 10 seconds

9.1.4 Test Function NWS-20

Through the pressing and holding of the setup button, independent of the state of NWS, the switching output can be temporarily switched off.

During the test phase, the LED blinks rapidly.

Releasing the button returns the NWS after ca. 3 sec. to the current operating condition.

9.2 Settings for NWS-...23/24 and NWS-2E

9.2.1 Signalling the operating status

The NWS has an output status indicator with an LED monitor that can be viewed continuously through a lense in the cover. The LED flashes approximately once every second when the NWS is off. It is continuously illuminated when the NWS is switched on. The LED provides visual confirmation that the NWS is operating correctly and that the status of the wet side is correctly displayed. With its operating mode switch, the NWS can be set to operate as either an N/C contact or an N/O contact.

9.2.2 Selecting operating mode

By reversing the polarity of the power supply, the switching function of the NWS-...23/24 can be changed from a N/C contact to a N/O contact.

For the NWS-2E the operating modus is selected by connecting the corresponding connector (plug connector or cable pin assignment) (see 8.2).

Function	Signalling	NAMUR-output	fork
N/C	LED on	$\geq 2.1 \text{ mA}$	uncovered
	LED flashes quickly	$\leq 0.8 \text{ mA}$	covered
N/O	LED on	$\geq 2.1 \text{ mA}$	covered
	LED flashes quickly	$\leq 0.8 \text{ mA}$	uncovered

9.2.3 Calibration mode NWS-23/24 and NWS-2E

Each appliance is adjusted by the factory to record fluids with density 1.0 kg/l (water). It is not usually necessary to alter this pre-adjustment. In extreme situations, however, such as with very light fluids at high temperatures or highly viscous fluids, which produce a significantly extended reaction time from dry to wet, it can be advantageous to alter the pre-adjustment. In the calibration mode for NWS-2E, the NAMUR loop current changes with the state of the LED signal. Therefore, the subsequent signal evaluation should be suppressed during the calibration process. In order to attain the calibration mode the test magnet must be placed at the label marking and held, then the supply voltage must be switched on. After approximately 1 second the LED goes on, after 2 seconds the LED goes out, then remove the test magnet – the appliance stays now in the main menu of the calibration mode.

There is a choice of options in the main menu - Switchpoint Calibration, Hysteresis Level and LED Mode (not NWS-2E). The LED indicates the selected option:

- Switchpoint Calibration: LED flashes briefly 1x, then LED 2 seconds off.
- Hysteresis Level: LED flashes briefly 2x, then LED 2 seconds off.
- LED Mode: LED flashes briefly 3x, then LED 2 seconds off (not NWS-2E).

The option points are repeated in an infinite loop.

In order to get access to an option the test magnet must be placed briefly when the LED has signalled the requested option point.

Switchpoint Calibration:

The "Switchpoint Calibration Mode" is signalled by: LED 1x briefly off, then LED 2 seconds on.

Dip the tuning fork as far as the required switchpoint (1/2 – 2/3 of the fork length) in the medium and activate by placing the test magnet briefly. The calibration is made.

A successful calibration is signalled by the LED flashing quickly three times. Hysteresis and LED Mode are set back to default! After calibration the switch back to the main menu takes place.

Hysteresis Level:

The "Hysteresis Level Mode" is signalled by: LED 2x briefly off, then LED 2 seconds on. Activate by placing the test magnet briefly to get to the submenu.

- Hysteresis Level 1 (approx. 1-1.5mm): LED flashes briefly 1x, then LED 2 seconds off.
- Hysteresis Level 2 (approx. 3-4.5mm, Standard): LED flashes briefly 2x, then LED 2 seconds off.
- Hysteresis Level 3 (approx. 5-7.5mm): LED flashes briefly 3x, then LED 2 seconds off.

The choice of options is repeated in an infinite loop. To select an Hysteresis Level, the test magnet must be placed briefly after the flashing of the relevant LED. Three quick flashes of the LED signal that an option has been selected, then the switch back to the main menu is made.

LED Mode (not NWS-2E):

The "LED Mode" is signalled by: LED briefly 3x off, then LED 2 seconds on. Briefly activate the Setup button in order to attain the option menu LED Mode.

- LED Mode 1 (Standard): LED flashes briefly 1x, then LED 2 seconds off. LED shows the status of the switch output
- LED Mode 2: LED flashes briefly 2x, then LED 2 seconds off. LED indicates whether the tuning fork is wetted or not

The choice of options is repeated in an infinite loop. In order to select an "LED Mode" the test magnet must be placed briefly after the relevant flashing of the LED. Three quick flashes of the LED signal that an option has been selected. When the LED Mode has been successfully selected, the switch back to the main menu is made.

In order to leave the calibration mode, the appliance must be separated from the voltage supply for approx. 10 seconds

9.2.4 Test function

The magnet supplied with the device can be used to switch off the electrical output of the NWS- independent of status of the tuning fork. In this case, the magnet must be placed on the location indicated on the device nameplate. After approximately 2 seconds, the NWS- switches the output off and the LED begins blinking. After the magnet is removed, the output returns after 3 seconds to its previous state.

9.2.5 Selecting operating mode

The choice of plug connector or cable pin assignment determines whether the level switch is operated as an N/C contact or an N/O contact (see the section "Electrical connection" below).

10. Service and Maintenance

The functional behaviour of these devices is stable, even over long periods or time. Regular adjustments or similar procedures are not required. No maintenance of any type is required.

In the event that device faults are noted, this device should be immediately removed from service. The device contains no user-serviceable parts. Return the device to the manufacturer for examination.

11. Trouble Shooting

Devices that are operated in hazardous areas must not be modified in any way. Repairs must be performed by trained, qualified service personnel only. Defective devices should normally be returned to the manufacturer for examination.

12. Recommended Spare Parts

There are no recommended spare parts.

If the device becomes defective, it usually means that there is a fault in the device electronics that must be diagnosed and repaired.

In this case, we recommend that the device be returned to the manufacturer for servicing.

13. Technical Information

Operating instructions, data sheet, approvals and further information via the QR code on the device or via www.kobold.com

14. Order Codes

Operating instructions, data sheet, approvals and further information via the QR code on the device or via www.kobold.com

15. Dimensions

Operating instructions, data sheet, approvals and further information via the QR code on the device or via www.kobold.com

16. Disposal

Note!

- Avoid environmental damage caused by media-contaminated parts
- Dispose of the device and packaging in an environmentally friendly manner
- Comply with applicable national and international disposal regulations and environmental regulations.

Batteries

Batteries containing pollutants are marked with a sign consisting of a crossed-out garbage can and the chemical symbol (Cd, Hg, Li or Pb) of the heavy metal that is decisive for the classification as containing pollutants:

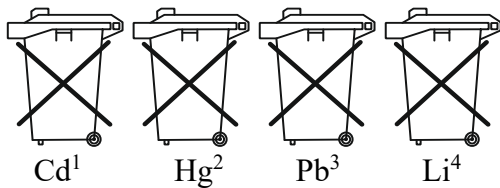

1. „Cd" stands for cadmium
2. „Hg" stands for mercury
3. „Pb" stands for lead
4. „Li" stands for lithium

Electrical and electronic equipment

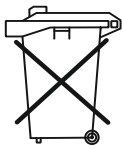

17. EU Declaration of Conformance (ATEX)

We, KOBOLD Messring GmbH, Nordring 22-24, 65719 Hofheim, Germany, declare under our sole responsibility that the product:

Product type: **Vibrating fork model NWS-*** 2E * ******

EU type examination certificate: **BVS 03 ATEX E 119**

Complies with all relevant requirements of the following directive(s):

2014/34/EU Equipment and protective systems intended for use in potentially explosive atmospheres

The following harmonized standards have been applied for conformity assessment:

EN IEC 60079-0:2018 Equipment - General requirements
EN 60079-11:2012 Equipment protection by intrinsic safety "i"
EN 60079-26:2015 Explosive atmospheres - Part 26: Equipment with Equipment Protection Level (EPL) Ga

The above-mentioned product complies with Directive 2014/34/EU. New editions may have already replaced one or more of the standards mentioned in the EU type examination certificates. Kobold Messring declares that the product mentioned in this declaration of conformity either meets the requirements of the new editions or is not affected by the changes.

The notified body DEKRA Testing and Certification GmbH, identification number: 0158, was activated, in accordance with Article 17 of Directive 2014/34/EU, to monitor quality assurance related to the production process.

Certificate: BVS 21 ATEX ZQS/E110

Hofheim, 14 Nov. 2023



H. Volz
General Manager

J. Burke
Compliance Manager

18. EU Declaration of Conformance

We, KOBOLD Messring GmbH, Nordring 22-24, 65719 Hofheim, Germany, declare under our sole responsibility that the product:

Level Switch model: **NWS -...**

to which this declaration relates is in conformity with the following EU directives stated below:

2011/65/EU **RoHS** (category 9)
2015/863/EU Delegated Directive (RoHS III)

Additionally, the options **23/24/2E/20** are in accordance with:

2014/30/EU **EMC Directive**

Additionally, the options **20** are in accordance with:

2014/35/EU **Low Voltage Directive**

All level switches type NWS comply with the following standard:

EN IEC 63000:2018 Technical documentation for the assessment of electrical and electronic products with respect to the restriction of hazardous substances

Additionally, the options **23/24** are in accordance with:

DIN EN 61000-4-4:2012 Electromagnetic compatibility (EMC) - Part 4-4: Testing and measurement techniques - Electrical fast transient/burst immunity test, BURST 2 kV

DIN EN 61000-4-2:2009 Electromagnetic compatibility (EMC) - Part 4-2: Testing and measurement techniques - Electrostatic discharge immunity test, ESD 8/4 kV

DIN EN 61000-4-5:2014 + A1:2017 Electromagnetic compatibility (EMC) - Part 4-5: Testing and measurement techniques - Surge immunity test, SURGE 1/2 kV

Additionally, the options **2E** are in accordance with:

DIN EN 61000-4-6:2014 Electromagnetic compatibility (EMC) - Part 4-6: Testing and measurement techniques - Immunity to conducted disturbances, induced by radio-frequency fields, HF coupling 3 V

EN IEC 61000-4-3:2020 Electromagnetic compatibility (EMC) - Part 4-3: Testing and measurement techniques - Radiated, radio-frequency, electromagnetic field immunity test, HF irradiation 10 V/m (tested up to 2.7 GHz)

DIN EN 61000-4-2:2009 Electromagnetic compatibility (EMC) - Part 4-2: Testing and measurement techniques - Electrostatic discharge immunity test, ESD 4/8 kV

DIN EN 61000-4-4:2012 Electromagnetic compatibility (EMC) - Part 4-4: Testing and measurement techniques - Electrical fast transient/burst immunity test, BURST 1/2 kV

DIN EN 61000-4-5:2019 Electromagnetic compatibility (EMC) - Part 4-5: Testing and measurement techniques - Surge immunity test, SURGE 1/2 kV

EN 55011:2016 + A1:2017 + A11:2020 + A2:2021 Industrial, scientific and medical equipment - Radio-frequency disturbance characteristics - Limits and methods of measurement, class B

Additionally, the options **20** are in accordance with:

EN IEC 61326-1:2021 Electrical equipment for measurement, control and laboratory use - EMC requirements - Part 1: General requirements, Industrial area (measurement of immunity to HF fields up to 2.7 GHz)

Hofheim, 14 Nov. 2023



H. Volz
General Manager

J. Burke
Compliance Manager

19. UK Declaration of Conformity

We, KOBOLD Messring GmbH, Nordring 22-24, 65719 Hofheim, Germany, declare under our sole responsibility that the product:

Level Switch model: **NWS** -...

to which this declaration relates is in conformity with the following UK directives stated below:

S.I. 2012/3032 The Restriction of the Use of Certain Hazardous Substances in Electrical and Electronic Equipment Regulations 2012

Additionally, the electronics options **23/24/2E/20** are in accordance with:

S.I. 2016/1091 Electromagnetic Compatibility Regulations 2016

Additionally, the electronics options **20** is in accordance with:

S.I. 2016/1101 Electrical Equipment (Safety) Regulations 2016

All level switches type NWS comply with the following standard:

BS EN IEC 63000:2018

Technical documentation for the assessment of electrical and electronic products with respect to the restriction of hazardous substances.

Additionally, the electronics options **23/24** are in accordance with:

BS EN 61000-4-4:2012 Electromagnetic compatibility (EMC). Testing and measurement techniques. Electrical fast transient/burst immunity test, BURST 2 kV

BS EN 61000-4-2:2009 Electromagnetic compatibility (EMC). Testing and measurement techniques. Electrostatic discharge immunity test, ESD 8/4 kV

BS EN 61000-4-5:2014 + A1:2017 Electromagnetic compatibility (EMC) - Testing and measurement techniques. Surge immunity test, SURGE 1/2 kV

Additionally, the electronics options **2E** are in accordance with:

BS EN 61000-4-6:2014 Electromagnetic compatibility (EMC) Testing and measurement techniques. Immunity to conducted disturbances, induced by radio-frequency fields, HF coupling 3 V

BS EN IEC 61000-4-3:2020 Electromagnetic compatibility (EMC) Testing and measurement techniques. Radiated, radio-frequency, electromagnetic field immunity test, HF coupling 10 V/m (tested up to 2.7 GHz)

BS EN 61000-4-2:2009 Electromagnetic compatibility (EMC). Testing and measurement techniques. Electrostatic discharge immunity test, ESD 8/4 kV

BS EN 61000-4-4:2012 Electromagnetic compatibility (EMC). Testing and measurement techniques. Electrical fast transient/burst immunity test, BURST 1/2 kV

BS EN 61000-4-5:2014 + A1:2017 Electromagnetic compatibility (EMC) - Testing and measurement techniques. Surge immunity test, SURGE 1/2 kV

BS EN 55011:2016 + A2:2021 Industrial, scientific and medical equipment. Radio-frequency disturbance characteristics. Limits and methods of measurement

Additionally, the electronics options **20** is in accordance with:

BS EN 61326-1:2013

Electrical equipment for measurement, control and laboratory use. EMC requirements. General requirements, Industrial area (Measurement of interference immunity to HF fields up to 2.7 GHz)

Hofheim, 21 Feb. 2024



H. Volz
General Manager



J. Burke
Compliance Manager

20. EU-Type Examination certificate



Translation

(1) 1. Supplement to the EC-Type Examination Certificate

- (2) Equipment and protective systems intended for use in potentially explosive atmospheres - Directive 94/9/EC Supplement accordant with Annex III number 6
- (3) No. of EC-Type Examination Certificate: **BVS 03 ATEX E 119**
- (4) Equipment: **Vibrating fork type NWS-***2E* ******
- (5) Manufacturer: **KOBOLD Messring GmbH**
- (6) Address: **Nordring 22-24, 65719 Hofheim/Ts., Germany**
- (7) The design and construction of this equipment and any acceptable variation thereto are specified in the appendix to this supplement.
- (8) The certification body of DEKRA EXAM GmbH, notified body no. 0158 in accordance with Article 9 of the Directive 94/9/EC of the European Parliament and the Council of 23 March 1994, certifies that this equipment has been found to comply with the Essential Health and Safety Requirements relating to the design and construction of equipment and protective systems intended for use in potentially explosive atmospheres, given in Annex II to the Directive. The examination and test results are recorded in the test and assessment report BVS PP 03.2083 EG.
- (9) The Essential Health and Safety Requirements are assured by compliance with:
- EN 60079-0:2012 General requirements**
EN 60079-11:2012 Intrinsic safety „i“
EN 60079-26:2007 Equipment with equipment protection level (EPL) Ga
- (10) If the sign "X" is placed after the certificate number, it indicates that the equipment is subject to special conditions for safe use specified in the appendix to this certificate.
- (11) This supplement to the EC-Type Examination Certificate relates only to the design, examination and tests of the specified equipment in accordance to Directive 94/9/EC. Further requirements of the Directive apply to the manufacturing process and supply of this equipment. These are not covered by this certificate.
- (12) The marking of the equipment shall include the following:

 **II 1G Ex ia IIC T6 Ga**

DEKRA EXAM GmbH
Bochum, dated 7th January 2013

Signed: Hans Christian Simanski

Certification body

Signed: Dr. Franz Eickhoff

Special services unit



- (13) Appendix to
- (14) **1. Supplement to the EC-Type Examination Certificate
BVS 03 ATEX E 119**
- (15) 15.1 Subject and type

Vibrating fork type NWS-***2E* ****
 Instead of the * in the complete denomination numerals and figures will be inserted which characterize different variations:
 type NWS-***2E* ****

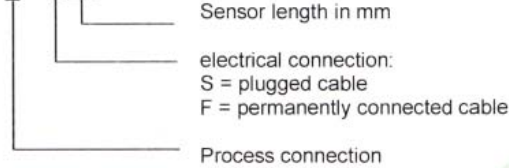

15.2 Description

The vibrating fork is used for measurement of liquid levels. The electrical components of the sensor are completely encapsulated in a metal enclosure. The electrical connection is by a plugged cable (type NWS-***2ES ****) or a permanently connected cable (type NWS-***2EF ****). The vibrating fork has to be protected from external physical impact.

For use in zone 0, the vibrating fork with plugged cable has to be installed in such a way, that electrostatic charging of the plug and cable can be excluded.

The vibrating fork can also be manufactured according to the documents listed in the test report; the vibrating fork has been slightly modified and assessed in accordance with the new standards.

15.3 Parameters

Maximum input voltage	U _i	DC	20	V
Maximum input current	I _i		100	mA
Maximum input power	P _i		1	W
Effective internal capacitance	C _i		8	nF
Effective internal inductance	L _i		negligible	

For the connected cable, the following values have to be additionally regarded:
 Capacitance per unit length 0,14 nF/m
 Inductance per unit length 0,65 µH/m

Ambient temperature range Ta -40 °C up to +70 °C

The possible medium temperature and the allocation of the temperature class are shown in the following table:

Temperature class	T6	T5	T4	T3
Max. medium temperature	75 °C	90 °C	125 °C	150 °C

- (16) Test and assessment report
BVS PP 03.2083 EG as of 07.01.2013



(17) Special conditions for safe use Installation instructions

None

We confirm the correctness of the translation from the German original.
In the case of arbitration only the German wording shall be valid and binding.

DEKRA EXAM GmbH
44809 Bochum, 7th January 2013
BVS-/Le/Ma A 20120463

Certification body

Special services unit

21. IECEx Certificate

		<h2 style="margin: 0;">IECEx Certificate of Conformity</h2>	
<p>INTERNATIONAL ELECTROTECHNICAL COMMISSION IEC Certification Scheme for Explosive Atmospheres <small>for rules and details of the IECEx Scheme visit www.iecex.com</small></p>			
Certificate No.:	IECEx BVS 13.0004	issue No.:0	Certificate history: _____
Status:	Current		
Date of Issue:	2013-01-08	Page 1 of 3	
Applicant:	KOBOLD Messring GmbH Nordring 22-24 65719 Hofheim/Ts. Germany		
Electrical Apparatus: <i>Optional accessory:</i>	Vibrating fork type NWS-***2E* ****		
Type of Protection:	Equipment protection by intrinsic safety "I", Equipment with equipment protection level (EPL) Ga		
Marking:	Ex ia IIC T6 Ga		
Approved for issue on behalf of the IECEx Certification Body:	H.-Ch. Simanski		
Position:	Head of Certification Body		
Signature: <i>(for printed version)</i>			
Date:			
1. This certificate and schedule may only be reproduced in full. 2. This certificate is not transferable and remains the property of the issuing body. 3. The Status and authenticity of this certificate may be verified by visiting the Official IECEx Website .			
Certificate issued by:			
DEKRA EXAM GmbH Dinnendahlstrasse 9 44809 Bochum Germany		DEKRA EXAM GmbH	

	IECEX Certificate of Conformity	
Certificate No.:	IECEX BVS 13.0004	
Date of Issue:	2013-01-08	Issue No.: 0
		Page 2 of 3
Manufacturer:	KOBOLD Messring GmbH Nordring 22-24 65719 Hofheim/Ts. Germany	
Additional Manufacturing location (s):		
<p>This certificate is issued as verification that a sample(s), representative of production, was assessed and tested and found to comply with the IEC Standard list below and that the manufacturer's quality system, relating to the Ex products covered by this certificate, was assessed and found to comply with the IECEx Quality system requirements. This certificate is granted subject to the conditions as set out in IECEx Scheme Rules, IECEx 02 and Operational Documents as amended.</p>		
STANDARDS: The electrical apparatus and any acceptable variations to it specified in the schedule of this certificate and the identified documents, was found to comply with the following standards:		
IEC 60079-0 : 2011 Edition: 6.0	Explosive atmospheres - Part 0: General requirements	
IEC 60079-11 : 2011 Edition: 6.0	Explosive atmospheres - Part 11: Equipment protection by intrinsic safety "i"	
IEC 60079-26 : 2006 Edition: 2	Explosive atmospheres - Part 26: Equipment with equipment protection level (EPL) Ga	
<p><i>This Certificate does not indicate compliance with electrical safety and performance requirements other than those expressly included in the Standards listed above.</i></p>		
TEST & ASSESSMENT REPORTS: A sample(s) of the equipment listed has successfully met the examination and test requirements as recorded in		
<u>Test Report:</u> DE/BVS/ExTR13.0003/00		
<u>Quality Assessment Report:</u> DE/BVS/QAR09.0001/04		

		IECEX Certificate of Conformity	
Certificate No.:	IECEX BVS 13.0004	Issue No.:	0
Date of Issue:	2013-01-08	Page	3 of 3
Schedule			
EQUIPMENT: <i>Equipment and systems covered by this certificate are as follows:</i>			
<u>Subject and type</u> see Annex			
<u>Parameters</u> see Annex			
CONDITIONS OF CERTIFICATION: NO			

Annexe: BVS_13_0004_kobold_Annex_a.pdf