



Low Volume Rotating Vane Flowmeter for liquids



measuring
•
monitoring
•
analysing

DPL



Model: DPL



Model: DPL with
compact electronics

- Measuring ranges:
0.025 - 0.5 ... 1 - 25 l/min water
- Linearity: $\pm 1\%$
- p_{\max} : 10 bar; t_{\max} : 70 °C
- Viscosity range: low viscosity
- Connection: G 1/2 male, hose connector
- Material of case: PP
- Output: pulse
- Without magnets or metal parts
- Medium: infrared light transmissive

S4



KOBOLD companies worldwide:

AUSTRALIA, AUSTRIA, BELGIUM, BULGARIA, CANADA, CHINA, CZECHIA, EGYPT, FRANCE, GERMANY, GREAT BRITAIN, HUNGARY, INDIA, INDONESIA, ITALY, MALAYSIA, MEXICO, NETHERLANDS, PERU, POLAND, REPUBLIC OF KOREA, ROMANIA, RUSSIA, SPAIN, SWITZERLAND, THAILAND, TUNISIA, TURKEY, USA, VIETNAM

KOBOLD Messring GmbH
Nordring 22-24
D-65719 Hofheim/Ts.
Head Office:
+49(0)6192 299-0
+49(0)6192 23398
info.de@kobold.com
www.kobold.com

Application

The KOBOLD flowmeter models DPL are used to measure and monitor liquids. Its compact design allows it to be used in equipment where space is at a premium. The large number of pulse evaluation options offered means that the system is suited for a wide range of applications.



Areas of Application

- Low viscosity liquids
- Non-conductive liquids
- Volume dosing with external electronics
- Filter aid
- Beverage industry

Technical Details

Accuracy:	± 2,5% of full scale ± 5% of full scale (OEM version)
Linearity:	1% of full scale
Medium temperature:	-40 ... +70 °C
Ambient temperature:	-30 ... +60 °C
Max. operating pressure:	10 bar
Protection:	IP 65

Materials

Housing:	polypropylene
Rotating vane:	polypropylene
Axle/bearing:	sapphire
Vane mount:	polysulfone
Gasket:	NBR, FPM or EPDM

Operating Principles

The medium flows through a specially shaped flow housing and causes a vane to rotate. This rotary motion is sensed by optoelectronics in a non-contacting manner, and converted to an asymmetric frequency signal or an analogue signal. A frequency divider with symmetrical output is available as an option. The frequency is proportional to the flow velocity.

The vane is sapphire-supported: this ensures a high degree of linearity and long service life.

Electronics

● Frequency output (OEM without CE-Sign)

Power supply:	4.5 - 12 V _{DC}
Supply current:	typ. 7 mA
Signal amplitude high:	approx. power supply
Signal amplitude low:	≤ 0.2 V
Transmitter cut-off voltage:	3 V max.
Transmitter supply current:	8 - 12 mA
Output loss:	max. 2.5 mWatt
Electrical connection:	solder pins
Pulse output:	NPN, Open Collect., max. 10 mA

● Frequency output (option frequency divider)

Power supply:	24 V _{DC} ±20%
Supply current:	40 - 50 mA
Signal amplitude high:	approx. power supply
Signal amplitude low:	≤ 0.2 V
Output loss:	max. 2.5 mWatt
Electrical connection:	plug M12x1 (option: 2 m PVC cable)
Division ratio (option):	1... ¹ / ₁₂₈ factory set
Pulse output:	PNP, open collector, max. 20 mA

● Analogue output (option plug-on display)

Power supply:	24 V _{DC} ±20%
Output:	0-20 mA or 4-20 mA, 3-wire technology
Max. load:	500 Ω
Electrical connection:	plug connector M12x1 or DIN 43 650
Option:	plug-on display (with plug connector DIN 43 650 only)

● Compact electronics

Display:	3-position LED
Analogue output:	(0)4...20 mA adjustable, max. 500 Ω
Switching outputs:	1 (2) semiconductor PNP or NPN, factory set
Contact operation:	programmable N/C/ N/O contact via 2 buttons
Setting:	
Power supply:	24 V _{DC} ±20%, approx. 100 mA, 3-wire technology
Electrical connection:	plug connector M12x1



Order Details (Example: DPL-1P05 G4 0000)

Meas. range [l/min] water	approx. frequency [Hz] at max. value	approx. pressure [bar] at max. value	Gasket model			Connection	Electronic analyser
			NBR	FPM	EPDM		
0.025 - 0.5	272	0.77	DPL-1P05	DPL-1V05	DPL-1E05	G4..= G 1/2 male S4..= Hose connector (for inner Ø of hose 12 mm + 14 mm)	Frequency output ..0000 = frequency output, NPN, without cable (OEM), no CE ..0500 = as 0000 but with 2 m cable ..F300 = frequency output, plug M12x1, PNP ..F320 = frequency divider 1:2, plug M12x1, PNP ..F340 = frequency divider 1:4, plug M12x1, PNP ..F390 = freq. divider 1...1/128, plug M12x1, PNP ..F500 = frequency output, PNP, 2m PVC cable ..F520 = frequency divider 1:2, 2m PVC cable, PNP ..F540 = frequency divider 1:4, 2m PVC cable, PNP ..F590 = freq. divider 1...1/128, 2m PVC cable, PNP Analogue output ..L303 = 0-20 mA output, M12x1 plug ..L343 = 4-20 mA output, M12x1 plug ..L403 = 0-20 mA output, plug DIN 43 650 ..L443 = 4-20 mA output, plug DIN 43 650 Compact electronics* ..C3R = LED display, 2x open collector, PNP, plug M12x1 ..C30M = LED display, 2x open collector, NPN, plug M12x1 ..C34P = LED display, 4-20 mA, 1x open collector, PNP, plug M12x1 ..C34N = LED display, 4-20 mA, 1x open collector NPN, plug M12x1
0.05 - 1.8	471	0.77	DPL-1P10	DPL-1V10	DPL-1E10		
0.2 - 6	505	0.70	DPL-1P15	DPL-1V15	DPL-1E15		
0.4 - 12	265	1.0	DPL-1P20	DPL-1V20	DPL-1E20		
1 - 25	399	1.3	DPL-1P25	DPL-1V25	DPL-1E25		

* Please specify flow direction in writing

Plug-on Display

for model DPL...L443... (with 4 -20 mA output and DIN plug connector)

Description	Order number
4-position LED, plug connector DIN 43 650, 3-wire, power supply through analogue output	AUF-3000

Electrical Connection

DPL..0000

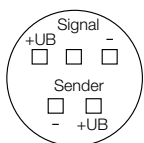

DPL..L3 / DPL..F3

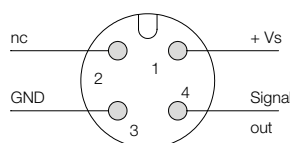

DPL..C

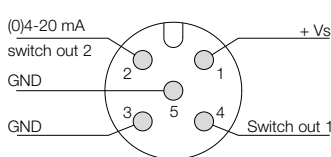

DPL..L4

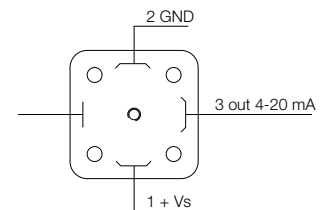

DPL...F5...

brown: +Vs
 blue: GND
 black: signal



Low Volume Rotating Vane Flowmeter Model DPL

Dimensions [mm]

DPL-...0000

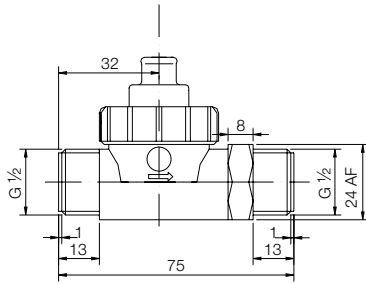

DPL-...F3.; DPL-...L3...

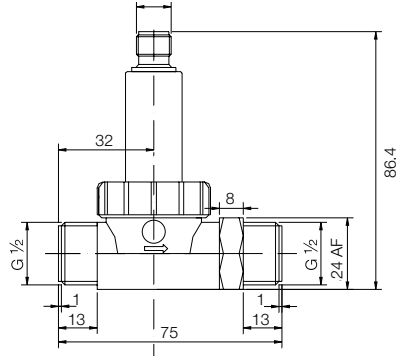

DPL-...C with compact electronics

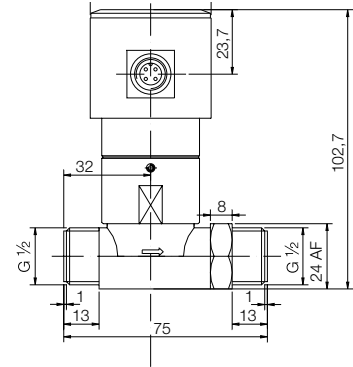

DPL-...L4... with analogue output and plug-on display

