

Operating Instructions for Compact Magnetic-Inductive Flow Meter

Model: MIK



MIK with
frequency-, switching-, analogue output



MIK with
compact electronic



MIK with
digital plug on display



Display rotatable in 90° steps

1. Contents

1. Contents.....	2
2. Note	4
3. Instrument Inspection.....	4
4. Regulation Use	5
5. Operating Principle.....	5
5.1 General.....	5
5.2 Minimum electrical conductivity / contained gases	5
5.3 Deposits.....	6
5.4 Measuring electrodes	6
6. Mechanical Connection.....	7
6.1 Check operating conditions.....	7
6.2 Installation.....	7
7. Electrical Connection	9
7.1 General.....	9
7.2 MIK-...S300.....	9
7.3 MIK-...S30D	9
7.4 MIK-...F300; MIK-...L3x3.....	10
7.5 MIK-...L443	10
7.6 MIK-...C30.....	10
7.7 MIK-...C34.....	10
7.8 MIK-...Ex4R, MIK-...Gx4R.....	11
7.9 MIK-...C3T0	12
8. Operation	13
8.1 Switch point setting MIK-...S300, MIK-...S30D	13
8.2 Counter electronics MIK-...Ex4R.....	13
8.3 Dosing electronics MIK-...Gx4R	13
9. Adjustment – Compact Electronics DUK-...C3T0.....	13
10. Adjustments – Compact Electronics MIK-...C30/C34.....	14
10.1 Button function.....	14
10.2 Settings.....	14
10.3 Value setting	15
10.4 Set-up mode	16
10.5 Main menu items	18
11. Device status - compact electronics MIK-...C3T0.....	21
12. Maintenance	21
13. Technical Information.....	22
14. Order Codes	22
15. Dimensions	22
16. Disposal	23
17. IO-Link (electronics MIK-C3T0 only)	24
17.1 IO-Link function.....	24
17.2 Specification	24
18. Appendix.....	25
18.1 IO-Link process data structure.....	25
18.2 IO-Link diagnosis information	26

18.3 IO-Link system command table.....	28
18.4 IO-Link ISDU parameter table	29
19. Manufacturer's declaration.....	38
20. EU Declaration of Conformance	40
21. UK Declaration of Conformity.....	41

Manufactured and sold by:

Kobold Messring GmbH
Nordring 22-24
D-65719 Hofheim
Tel.: +49(0)6192-2990
Fax: +49(0)6192-23398
E-Mail: info.de@kobold.com
Internet: www.kobold.com

2. Note

Please read these operating instructions before unpacking and putting the unit into operation. Follow the instructions precisely as described herein.

The instruction manuals on our website www.kobold.com are always for currently manufactured version of our products. Due to technical changes, the instruction manuals available online may not always correspond to the product version you have purchased. If you need an instruction manual that corresponds to the purchased product version, you can request it from us free of charge by email (info.de@kobold.com) in PDF format, specifying the relevant invoice number and serial number. If you wish, the operating instructions can also be sent to you by post in paper form against an applicable postage fee.

Operating instructions, data sheet, approvals and further information via the QR code on the device or via www.kobold.com

The devices are only to be used, maintained and serviced by persons familiar with these operating instructions and in accordance with local regulations applying to Health & Safety and prevention of accidents.

When used in machines, the measuring unit should be used only when the machines fulfil the EC-machine guidelines.

as per PED 2014/68/EU

In acc. with Article 4 Paragraph (3), "Sound Engineering Practice", of the PED 2014/68/EU no CE mark.

Diagram 8, Pipelines, Group 1, dangerous fluids

3. Instrument Inspection

Instruments are inspected before shipping and sent out in perfect condition.

Should damage to a device be visible, we recommend a thorough inspection of the delivery packaging. In case of damage, please inform your parcel service / forwarding agent immediately, since they are responsible for damages during transit.

Scope of delivery:

The standard delivery includes:

- Compact Magnetic-Inductive Flow Meter model: MIK

4. Regulation Use

Any use of the Compact Magnetic-Inductive Flow Meter, model: MIK, which exceeds the manufacturer's specifications, may invalidate its warranty. Therefore, any resulting damage is not the responsibility of the manufacturer. The user assumes all risk for such usage.

5. Operating Principle

5.1 General

The new KOBOLD flow meter Type MIK is used for measuring and monitoring smaller and medium-sized flow of conductivity liquids in pipes. The device operates according to the electromagnetic measuring method. According to Faraday's Law of electromagnetic induction a voltage is induced in a conductor moving through a magnetic field. The electroconductive measuring medium acts as the moved conductor. The voltage induced in the measuring medium is proportional to the flow velocity and is therefore a value for the volumetric flow. The flowing media must have a minimum conductivity. The induced voltage is picked up by two sensing electrodes which are in contact with the measuring medium and sent to the measuring amplifier. The flow rate will be calculated based on the cross-sectional area of the pipe.

The measurement is not depending on the process liquid and its material properties such as density, viscosity and temperature.

The device may be equipped with a switch, frequency or analogue output.

In addition, a universal compact electronics type C3T0 is available, which provides two outputs that can be configured by the customer.

5.2 Minimum electrical conductivity / contained gases

It is necessary for the correct function of the device that the current canal is always filled completely with medium.

As of a minimum electrical conductivity of 30 $\mu\text{S}/\text{cm}$ the MIK works within the guaranteed margins of error. The conductivity of the medium is continuously monitored by the device's electronic system. If the electronic system registers that the conductivity has under-run minimum, the output signal is suppressed for 2 seconds, after which the value for zero flow is output.

Air bubbles in the flowing medium or media with changing conductivity in the range of the minimum conductivity can interfere with the measuring function and reduce the MIK's measuring accuracy.

The gases contained in the fluid are included in the volume flow measurements and consequently cause erroneous measurements. If necessary, suitable vents should be fitted upstream in the device.

5.3 Deposits

Minor deposits on the measuring tube do not compromise the accuracy of measurement in general, as long as their conductivity does not seriously deviate from that of the fluid. In the case of fluids that have a tendency to deposit sediment, the measuring tube should be checked at regular intervals and cleaned if necessary.

5.4 Measuring electrodes

The electrodes used with the MIK have a galvanic pick-off. They are in direct contact with the fluid and are fitted opposite one another, and insulated from the measuring tube. The standard electrodes are made of 1.4404 stainless steel or Hastelloy C4.

6. Mechanical Connection

6.1 Check operating conditions

- flow rate
- max. operating pressure
- max. operating temperature

In general, the MIK is subjected to the same loads as the piping into which it is installed. The MIK should therefore be kept away from extreme loads, such as pressure surges with strong, dynamic pipe movements, vibrations in the proximity of centrifugal pumps, high temperature media, flooding etc.

6.2 Installation

- Remove all packing materials and transport retainers and ensure that no such materials remain in the device.
- It can be installed in vertical, horizontal or rising pipes. Flow in direction of the arrow.
- Avoid pressure and tensile load.
- Mounting the inlet and outlet pipe in a distance of 50 mm from the connections.



Attention! The sensor housing made of PPS and PVDF is not allowed to be subjected to a torsional stress during installation. The connecting of the respective connection thread with the pipeline should be adapted to the material used, over tightening the connection will damage the sensor housing, a loose tightening may result in loosening the connection.

- Avoid valves or large reduction on the inlet section (this increases the inaccuracy of measurements).
- Check the leak tightness of the connections.



Danger! Opening the screw ring of the C3T electronics will void the guarantee.

- The electronic display can be rotated in 90° steps via software. See chapter 5.3 of the C3T0 operating instructions.

in- and outlet

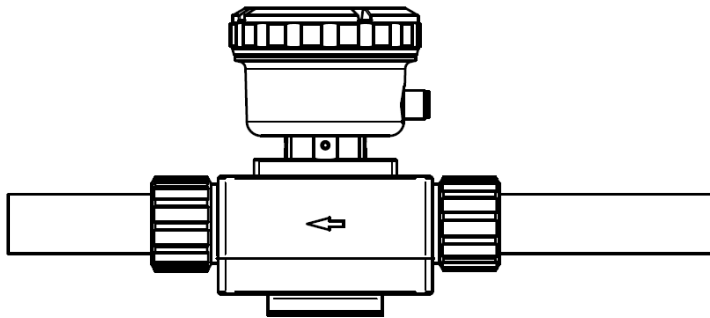

mounting top down

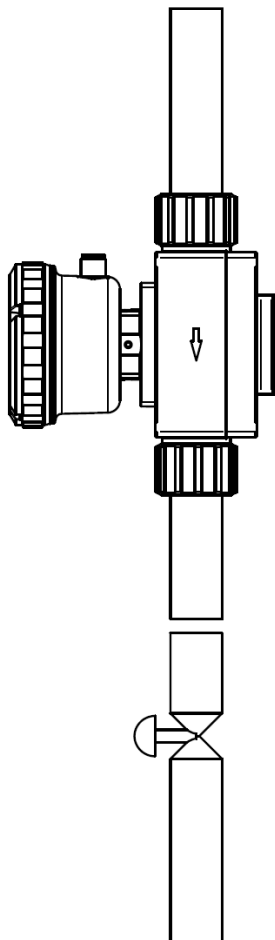

avoid this mounting position

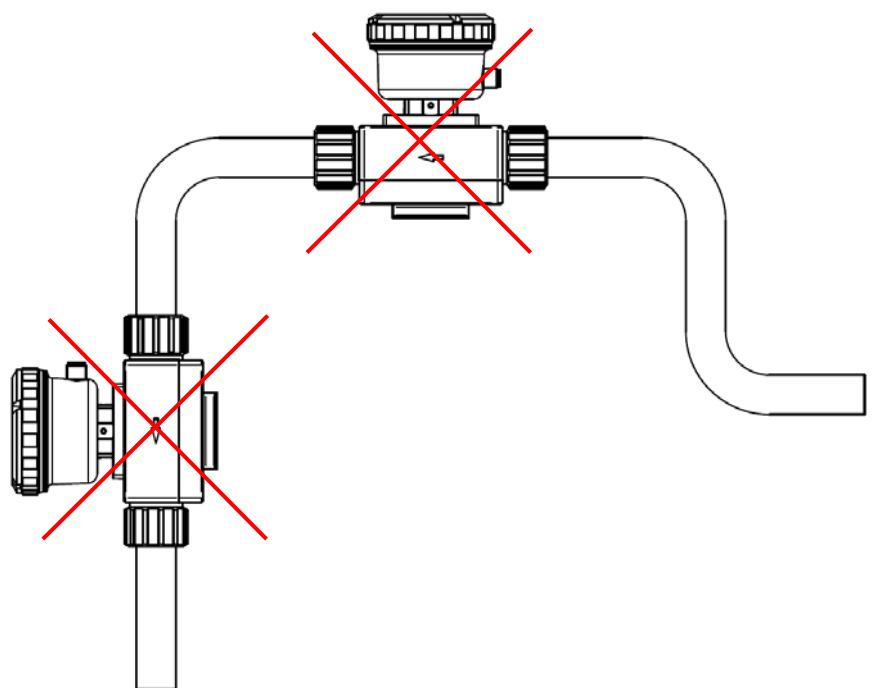

7. Electrical Connection

7.1 General



Attention! Make sure that the voltage values of your system correspond with the voltage values of the measuring unit.

- Make sure that the supply wires are de-energised.
- Connect the supply voltage and the output signal **to the plug PIN's as stated below.**
- We recommend the use of wires with cross sectional area of min. 0,25 mm².



Attention! The measuring electrodes are galvanically connected with the reference potential of the supply voltage and the signal output.

7.2 MIK-...S300

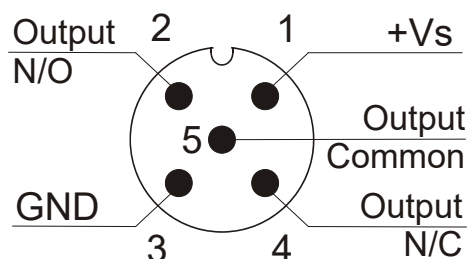

7.3 MIK-...S30D

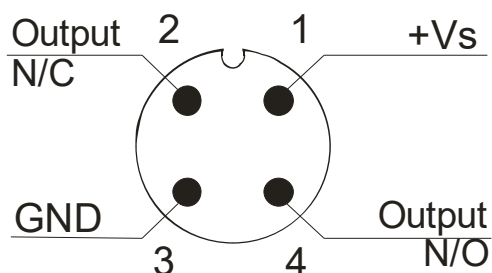

7.4 MIK-...F300; MIK-...L3x3

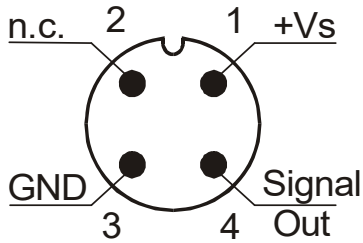

Connection example MIK-...L3x3

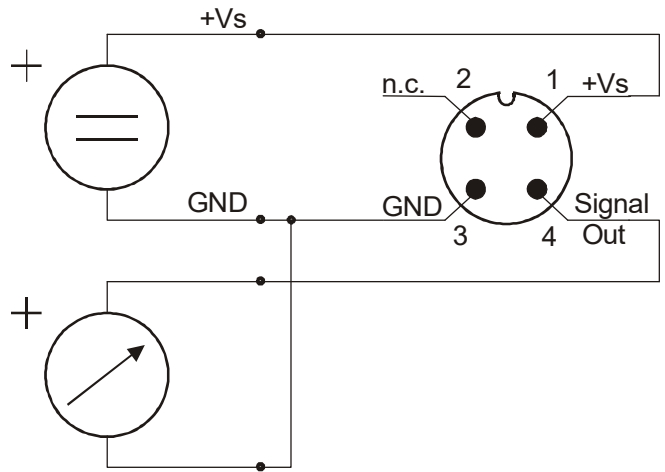

7.5 MIK-...L443

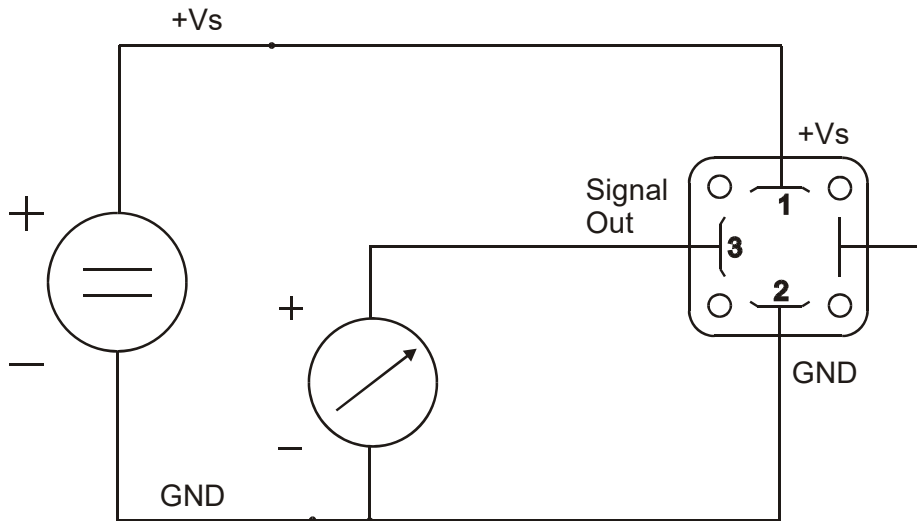

7.6 MIK-...C30..

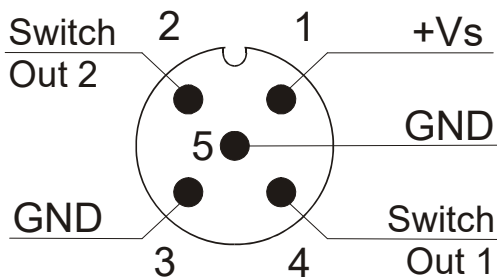

7.7 MIK-...C34..

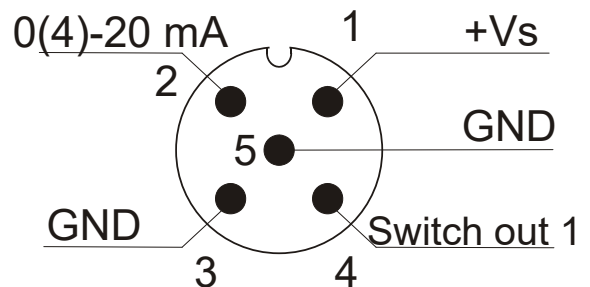

7.8 MIK-...Ex4R, MIK-...Gx4R

Cable connection

Wire number	MIK-...E14R Counter electronics	MIK-...G14R Dosing electronics
1	+24 V _{DC}	+24 V _{DC}
2	GND	GND
3	4-20 mA	4-20 mA
4	GND	GND
5	n. c.	Control 1*
6	Reset part quantity	Control 2*
7	Relay S1	Relay S1
8	Relay S1	Relay S1
9	Relay S2	Relay S2
10	Relay S2	Relay S2

*Control 1<->GND: Start-dosing

Control 2<->GND: Stop-dosing

Control 1 <-> Control 2 <-> GND: Reset-dosing

Plug connection

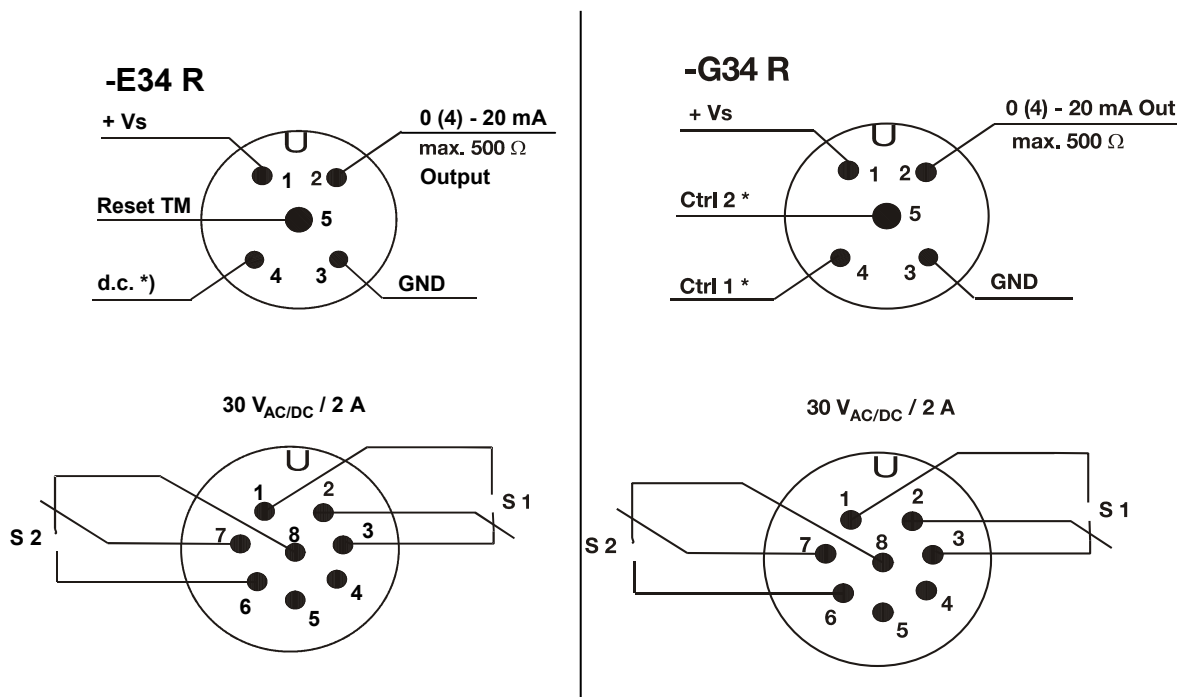

*) Do not connect!

7.9 MIK-...C3T0

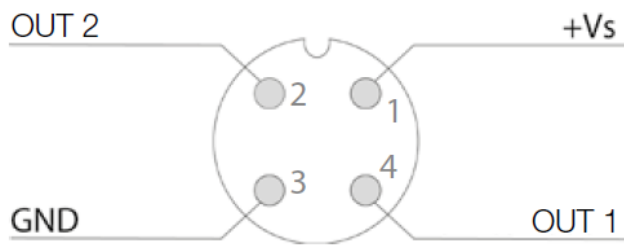

8. Operation

The units are preset and after electrical connection ready for operation.

8.1 Switch point setting MIK-...S300, MIK-...S30D

Switch setting	Switch point
0	Switch function deactivated
1	10 % of f.s.
2	20 % of f.s.
3	30 % of f.s.
4	40 % of f.s.
5	50 % of f.s.
6	60 % of f.s.
7	70 % of f.s.
8	80 % of f.s.
9	90 % of f.s.

Flow above switch point: DUO-LED green
Flow below switch point: DUO-LED red

8.2 Counter electronics MIK-...Ex4R

Operating please see Operating Instructions ZED-Z

8.3 Dosing electronics MIK-...Gx4R

Operating please see Operating Instructions ZED-D

9. Adjustment – Compact Electronics DUK-...C3T0

The operation and setting of the electronics option -C3T0 is described in the operating manual supplement for C3T0.

10. Adjustments – Compact Electronics MIK- ...C30/C34

Connect the compact electronics according to previous connection diagram and supply with the indicated power supply.

After power on, the measuring range (end current) will be shown for 3 seconds.

10.1 Button function

In the standard mode (measuring mode)

 : Press 3 sec. → Setup mode

 : Switch point/Window point

In the set-up mode

 : Next Step

 : Change Value

Any time

3 sec 

or do not press
a button for 20 sec

↓

Standard mode

10.2 Settings

The following values can be changed in the compact electronic:

	Scale range	Factory setting
Switch point (SPo , SP1 , SP2)	0...999	0,00
Hysteresis (HYS)	-199...0	-0,00
Window point (duo point) (duo)	Switch point ...999	--- (inactive)
Contact-type (Con , Co1 , Co2)	(no), (nc) or frequency (Fr)**	no
Start current (S-C)*	000...999	000
End current (E-C)*	000...999	FS
Start current selection (SCS)	0-- (0 mA), 4-- (4 mA)	4 mA
Change Code (CCo)	000...999	000

* Start- and end value of flow relating to 0/4-20 mA

** **not calibrated**, frequency at f.s. approx. 1100-1600 Hz

10.3 Value setting

From the main menu item (for example: switch point, "SPo"), press the "◆" button to set the value. The flow chart below illustrates the universal routine for changing individual parameters.

[From the main menu item]

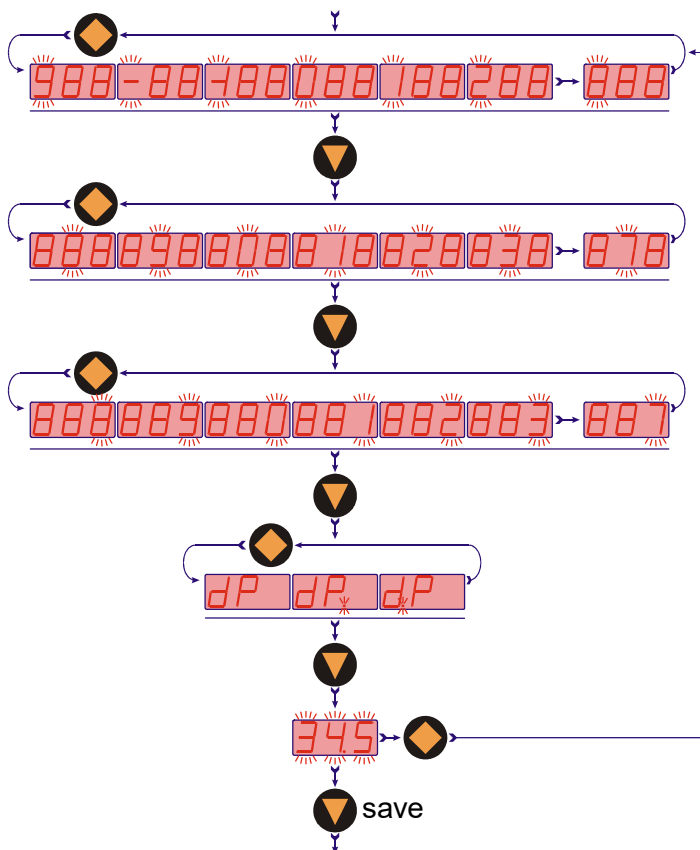

1. Adjust position

2. Adjust position

3. Adjust position

Adjust decimal point

Save selected value or enter new value. [To the next main menu item]

10.4 Set-up mode

Compact electronics MIK-...C30..

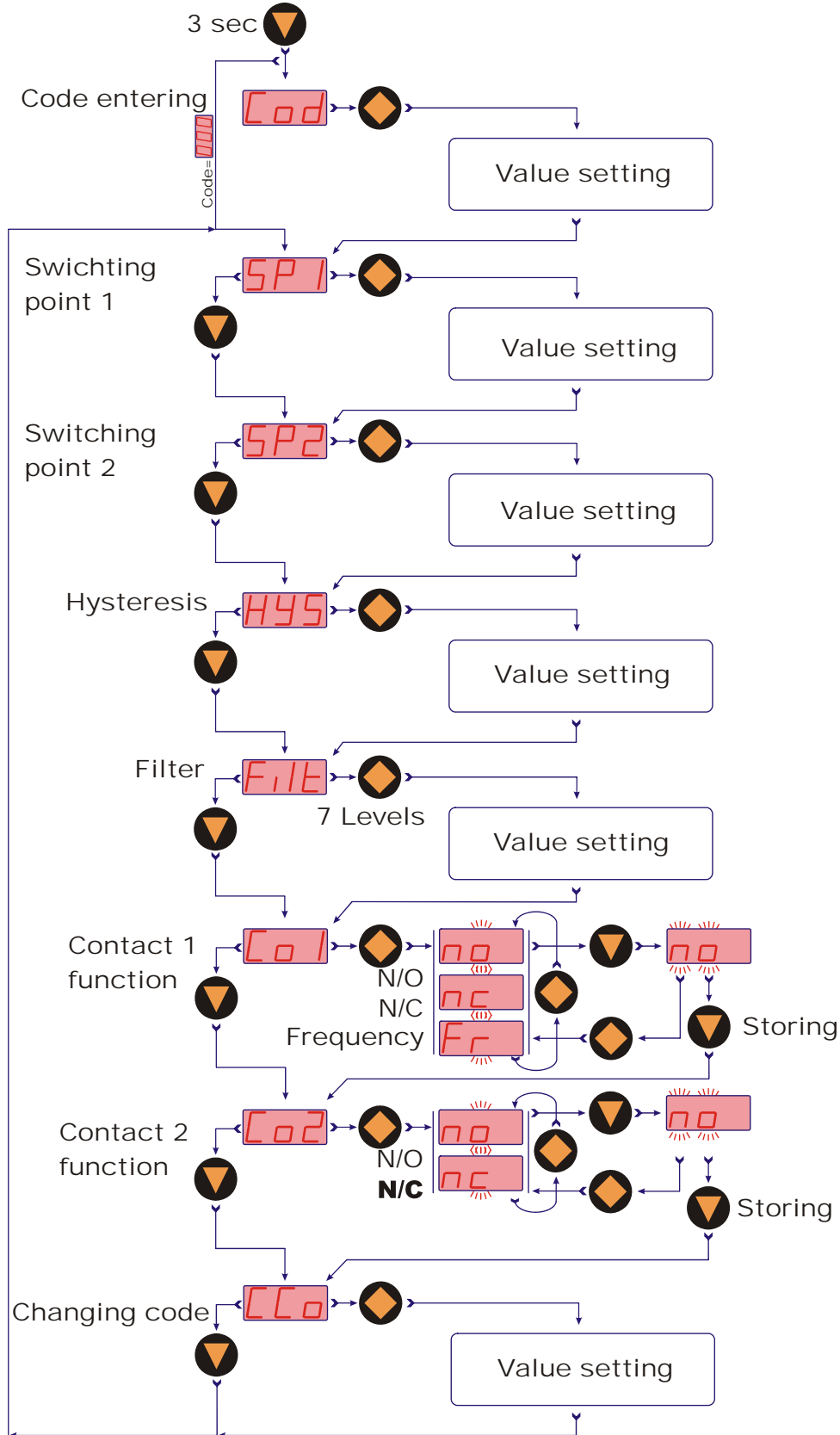

Compact electronics MIK-...C34..

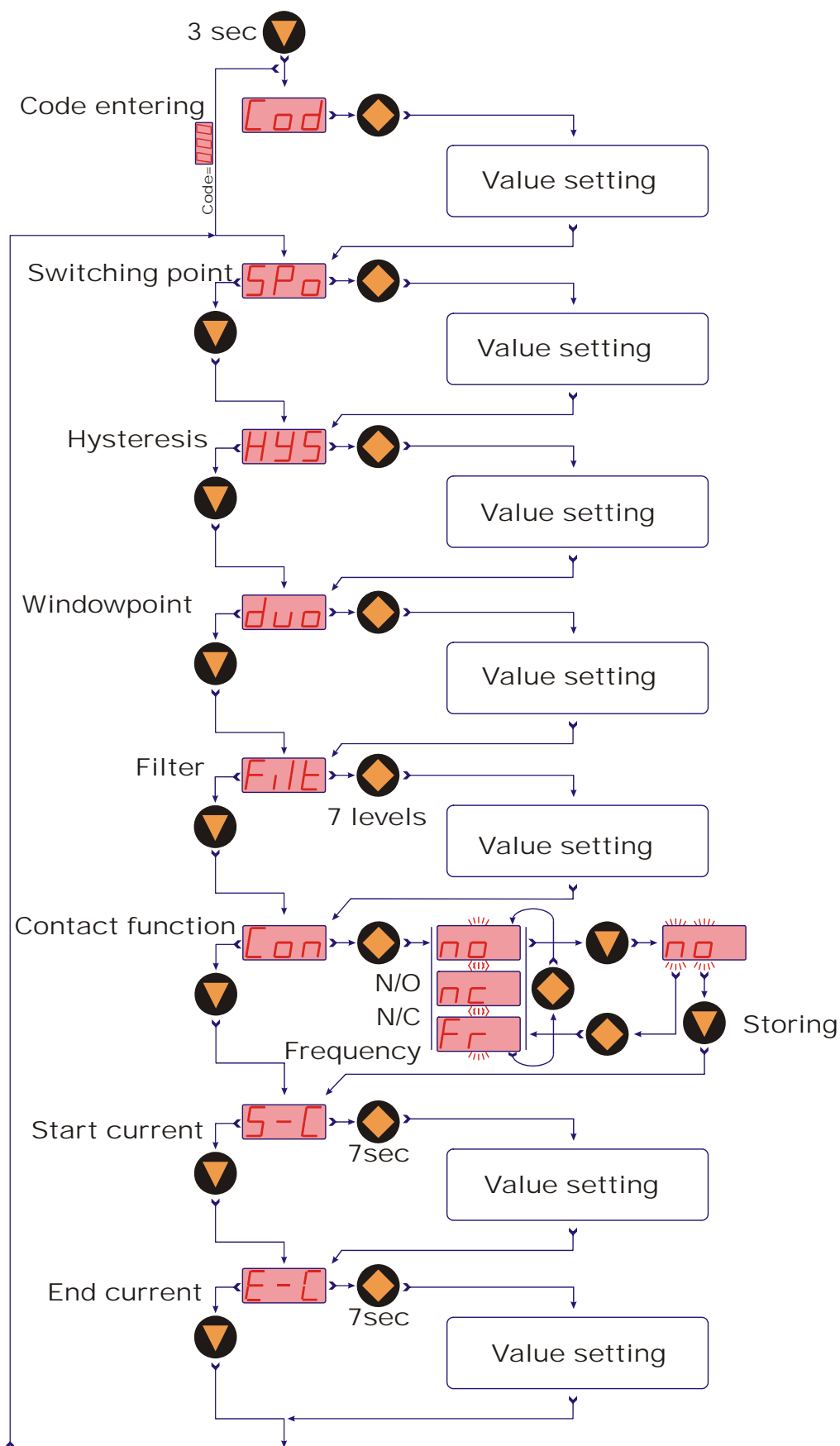

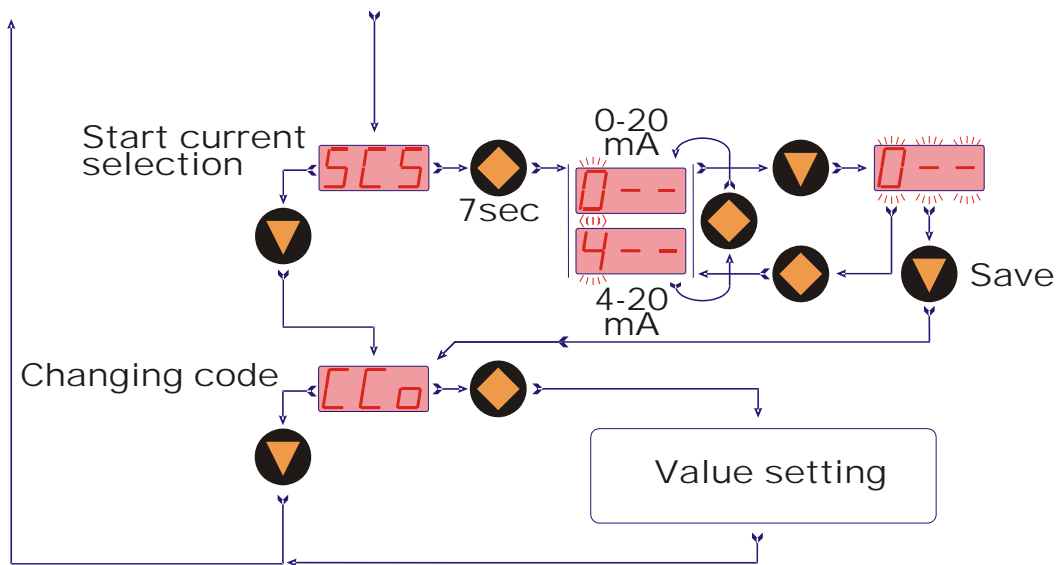

10.5 Main menu items

10.5.1 Switching point

The switching point is entered in the menu item "**Spo, SP1, SP2**". A setting value between 000 and 999 can be selected. This value can also include a decimal point. The decimal point can be set at two points (e.g. 10.0 or 1.00). If the display value exceeds the set switch point, the electronic is activated and is signalled by a lightning LED.

If the hysteresis is equal to zero and the window point is de-activated, the electronic switches back whenever the indicated value falls below the switching point.

10.5.2 Hysteresis

After the setting of the switching point, the hysteresis can be entered as a negative value in the "**HYS**" menu. The standard hysteresis value is zero. In operation condition this can lead to ambiguous switching behaviour, if the reading fluctuates around the switching point or window point. In this case, increasing the hysteresis can put things right. The hysteresis relates to the switching point and the window point (switching point minus hysteresis; window point plus hysteresis).

Example: Switch point 100 L/min; Hysteresis: -2.5 L/min

The electronics switches when 100 L/min is exceeded and switches back when the reading under-runs below 97.5 L/min.

10.5.3 Window point (duo-point)

As well as the switching point, it is also to define a "**duo**" (duo-point), the window point. This must be higher than the switching point. By using the window point and the switching point it is possible to monitor the measurement value in a certain range. The switching point limits the measurement range to smaller values and the window point to larger values.



If the window point (duo-point) is less than or equal to the switching point, an error report (Er4) will be indicated on the display and its value is deleted and its function is invalid (in the case that the window point and switching point out of adjustment).

The value is set in the same way as the switch point.

The window point is needed for process, in which monitoring of a certain measurement range is necessary.

Example: Switching point: 100 L/min; window point: 150 L/min;
hysteresis: -1 L/min

The electronic switches when 100 L/min is exceeded. If the measured value remains between 99 L/min (100-1) and 151 L/min (150+1), the contact will also remain in active switching condition (LED on). If it exceeds 151 L/min or is below 99 L/min the electronic switches back.

Switching behaviour

The following diagram clarifies the switching behaviour of the electronics. The contact closes (contact type: no) when exceeding below the switching point or when it under-runs the window point. It only opens again if the window point plus hysteresis is exceeded or if it drops below the switching point minus hysteresis. An **LED** indicates the switching condition of the switching point.

10.5.4 Filter

The filter function "**Filt**" forms a running average from the measured values. The following values can be set (see section 10.2 Settings):

1 / 2 / 4 / 8 / 16 / 32 / 64

They correspond to the number of samples used in the running average. The filter value determines the dynamic behaviour of the display value. The larger the adjusted value, the slower the display response. With a filter value of "1" the filter is switched off, i.e. the display value is equal to the unfiltered measured value.

The integrated step function detector reacts to a change of value corresponding to approx. 6.25% of the full scale value. As soon as a step function signal is detected, the instantaneous measured value is directly indicated in the display.

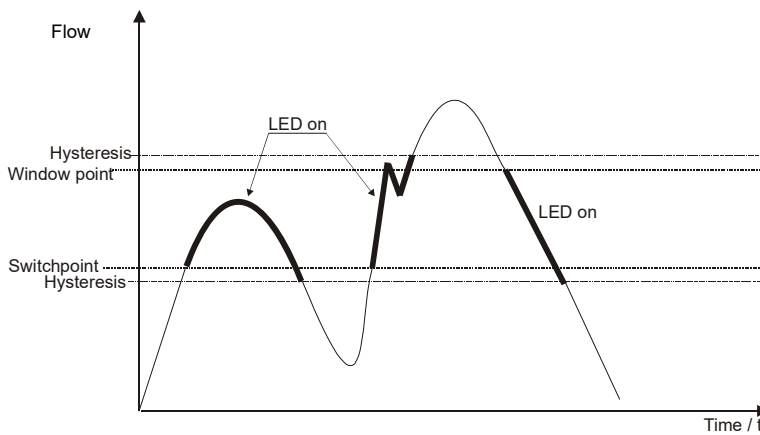
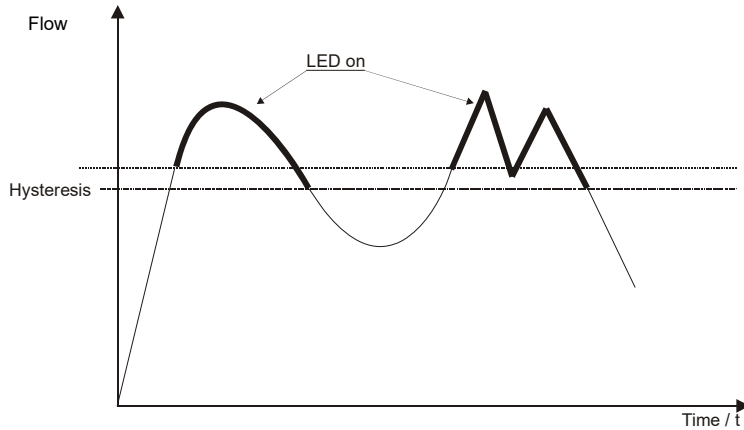

10.5.5 Contact type

The function of the transistor switching output is set in menu item "Con, Co1 or Co2". The switching function switches from

no - N/O contact to

nc - N/C to

Fr – frequency (only Con and Co1)

and back.

N/O contact: contact closes when switch point is exceeded

N/C contact: contact opens when switch point is exceeded

Frequency: frequency output is proportional to flow value

10.5.6 Current output

The current output is selected in menu items

"S-C" Start current indicated value < > 0(4) mA

"E-C" End current indicated value < > 20 mA

"SCS" Start current selection (0-20 mA or 4-20 mA).

The indicated value at which 0(4) mA flow is entered in menu item start current.

The indicated value at which 20 mA flow is entered in menu item end current.

10.5.7 Change code

The change code option "**CCo**" secures the unit against unauthorised tampering. If the code is different from 000, the user must input the code immediately after entering the adjustment mode.

11. Device status - compact electronics MIK-...C3T0

The electromagnetic flow meter can detect and display various device or application errors. If there is a status or error message, the STATUS symbol in the display flashes alternately orange and red. To call up the status/error information, the status button must be pressed, then the status window that appears lists all the messages that have occurred up to this point in time. By pressing the ... key, the user confirms knowledge of the displayed errors, the status memory is deleted and the status window is closed. If one of the displayed errors persists, this is reported again by the status symbol flashing. The following status/error messages are generated:

Display text	Description	Debugging
<i>Empty Pipe</i>	Measuring tube is not completely filled with medium or medium with insufficient conductivity is used.	Check the filling of the measuring circuit or the conductivity of the medium (>20 µs/cm)
<i>Temp Sens Error</i>	Error in the temperature measuring circuit	Repair by KOBOLD Service required
<i>Meas saturated</i>	Flow measurement circuit overloaded	Decrease flow rate
<i>No Subslave</i>	Internal hardware error	Reparatur durch KOBOLD Service notwendig
<i>Simulation</i>	Simulation function active	-

12. Maintenance

The measurement device requires no maintenance if the measurement medium does not cause deposits. In order to avoid problems, we recommend the installation of a filter, such as the magnetic filter, model MFR.

If it is necessary to clean the sensor, the sensor can be rinsed with a suitable liquid. Fibre parts or large particles can be carefully removed with a cleaning cloth or similar.

Work on the electronics can only be performed by the factory, or the warranty is otherwise voided.

13. Technical Information

Operating instructions, data sheet, approvals and further information via the QR code on the device or via www.kobold.com

14. Order Codes

Operating instructions, data sheet, approvals and further information via the QR code on the device or via www.kobold.com

15. Dimensions

Operating instructions, data sheet, approvals and further information via the QR code on the device or via www.kobold.com

16. Disposal

Note!

- Avoid environmental damage caused by media-contaminated parts
- Dispose of the device and packaging in an environmentally friendly manner
- Comply with applicable national and international disposal regulations and environmental regulations.

Batteries

Batteries containing pollutants are marked with a sign consisting of a crossed-out garbage can and the chemical symbol (Cd, Hg, Li or Pb) of the heavy metal that is decisive for the classification as containing pollutants:

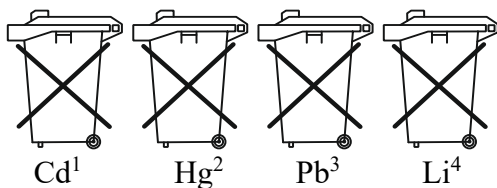

1. „Cd" stands for cadmium
2. „Hg" stands for mercury
3. „Pb" stands for lead
4. „Li" stands for lithium

Electrical and electronic equipment



17. IO-Link (electronics MIK-C3T0 only)

17.1 IO-Link function

The MIK-XXXXC3T0 flow meter has an IO-Link communication interface as standard. The process and diagnostic data can be accessed directly via this interface and the device can be parameterized.

Output 1 is factory configured for IO-Link function. If the IO-Link communication mode is active, the "IOLINK" symbol in the status display for the outputs is displayed in green. The settings menu remains locked when the IOLINK mode is active and is not accessible.

To ensure that the IO-Link device can be operated correctly on the connected IO-Link master, it is necessary to install the device description file that matches the device.

The device description files (IODD) are available in the IODDfinder database at ioddfinder.io-link.com.

Product-type	Device-ID [hex]	Device-ID [dec]
MIK-XXXXXC3T0	040300	262912

If the device is operated on an IO-Link master with port class A, only a maximum output current of 50 mA may be drawn from output 2 (OUT2) (current or binary output), otherwise the IO-Link master will be overloaded and malfunctions may occur.

17.2 Specification

Manufacturer ID	1105 (dezimal), 0x0451 (hex)
Manufacturer	Kobold Messring GmbH
IO-Link specification	V1.1
Bitrate	COM3
Minimum cycle time	1.1 ms
SIO-Mode	yes (OUT1 in configuration IO-Link)
Block parameterisation	yes
Ready for operation	10 s
Max. cable length	20 m
IO-Link master port class	A

18. Appendix

18.1 IO-Link process data structure

Process data length: 10 bytes

Byte number	Data	Bit counter	Format	Factor	Range	Value
0 - 3	Flow	32 Bit	FloatT		+/-1,4E-45 ... +/-3,4E+38	L/min
4 - 7	Volume	32 Bit	FloatT		+/-1,4E-45 ... +/-3,4E+38	L
8 - 9	Temperature	12 Bit	IntegerT	1/10	+/-204,8	°C
	reserved	1 Bit	BooleanT			
	reserved	1 Bit	BooleanT			
	Status OUT1	1 Bit	BooleanT			
	Status OUT2	1 Bit	BooleanT			

Flow (32 Bit, FloatT)																															
0	1	2	3	4	5	6	7	0	1	2	3	4	5	6	7	0	1	2	3	4	5	6	7	0	1	2	3	4	5	6	7
Byte 0								Byte 1								Byte 2								Byte 3							

Volume (32 Bit, FloatT)																															
0	1	2	3	4	5	6	7	0	1	2	3	4	5	6	7	0	1	2	3	4	5	6	7	0	1	2	3	4	5	6	7
Byte 4								Byte 5								Byte 6								Byte 7							

Temperature (12 Bit, IntegerT)															
0	1	2	3	4	5	6	7	0	1	2	3	4	5	6	7
Byte 8								Byte 9							

As long as a diagnostic status of the "Error" type is active for the flow or temperature process values, the corresponding transferred process values are invalid. The process values are only valid if the diagnostic status is deactivated accordingly.

18.2IO-Link diagnosis information

Event Code [hex]	Event Code [dec]	Name	Device Status	Type	Definition
0x7710	30480	Short Circuit		Error	check installation
0x8C10	35856	Process Variable Range Overrun		Warning	process data uncertain
0x8C20	35872	Measurement Range Overrun		Error	check application
0x8C30	35888	Process Variable Range Underrun		Warning	process data uncertain
0x1838	6200	1. Test Event For Protocol Testing		Error	first test event
0x1839	6201	2. Test Event For Protocol Testing		Error	secont test event
0x183A	6202	NVM Error	4	Error	non-volatile memory is corrupt
0x183B	6203	Subslave Lost		Error	communication to subslave interrupted
0x183C	6204	Subslave Not Found	4	Error	cummunication to subslave couldn't be established
0x183D	6205	Counter Overflow	2	Error	volume or partvolume counter overflowed
0x183E	6206	Simulation Active		Warning	indicades that one of the simulations is running
0x183F	6207	Flow MRE Overrun		Warning	measuring range overrun
0x1840	6208	Flow MRS Underrun		Warning	measuring range underrun
0x1841	6209	Flow Overflow Overrun	2	Warning	overflow range overrun
0x1842	6210	Flow Underflow Underrun	2	Warning	underflow range underrun
0x1847	6215	Temperature MRE Overrun		Warning	measuring range overrun
0x1848	6216	Temperature MRS Underrun		Warning	measuring range underrun
0x1849	6217	Temperature Overflow Overrun	2	Warning	overflow range overrun
0x184A	6218	Temperature Underflow Underrun	2	Warning	underflow range underrun

0x185F	6239	EmptyPipe	2	Warning	no media in tube
0x1860	6240	Temp Sensor Error	4	Error	no temperature sensor attached
0x1861	6241	Measure Saturated	2	Warning	ADC out of range

18.3IO-Link system command table

Command (hex)	Command (hex)	Command name
82	130	Restore factory settings
A0	160	Reset MinMax Flow
A1	161	unused
A2	162	Reset MinMax Temperature
A3	163	Reset Part Volume Counter
A4	164	unused
A5	165	unused
A6	166	unused
A7	167	unused
A8	168	Start Simulation Flow
A9	169	unused
AA	170	Start Simulation Temperature
AB	171	Start Simulation Part Volume
AC	172	unused
AD	173	unused
AE	174	unused
AF	175	unused
B0	176	Stop Simulation Flow
B1	177	unused
B2	178	Stop Simulation Temperature
B3	179	Stop Simulation Part Volume
B4	180	unused
B5	181	unused
B6	182	unused
B7	183	unused
B8	184	Events Handling ON
B9	185	Events Handling OFF

18.4IO-Link ISDU parameter table

Parameters that relate to the measured values of flow, temperature or volume must be entered in the basic units and, if necessary, converted beforehand. The basic units are:

Flow: **L/min**

Temperature: **°C**

Volume: **Liter**

Units conversion table

Category: Flow		
Unit	description	conversion
L/m	Liters per minute (basic unit)	-
L/h	Liters per hour	1 L/h = 0.0167 L/m
mL/m	Milliliters per minute	1 mL/m = 0.001 L/m
m ³ /h	Cubic meters per hour	1 m ³ /h = 16.667 L/m
gal/m	US gallons per minute	1 gal/m = 3.7854 L/m
gal/h	US gallons per hour	1 gal/h = 0.06309 L/m
galk/m	UK gallons per minute	1 galk/m = 4.54609 L/m
galk/h	UK gallons per hour	1 galk/h = 0.07577 L/m
L/s	Liters per second	1 L/s = 60 L/m
mL/s	Milliliters per second	1 mL/s = 0.0000167 L/m
USER	user unit	1 user unit = USER * L/m

Category: Temperature		
Unit	description	conversion
°C	degree Celsius (basic unit)	-
°F	degree Fahrenheit	$x \text{ °C} = (32 + x * 1,8) \text{ °F}$
USER	user unit	1 user unit = USER * °C

Category: Volume		
Unit	description	conversion
L	Liters (basic unit)	-
mL	Milliliters	1 mL = 0.001 L
m ³	Cubik meters	1 m ³ = 1000 L
galUS	US gallons	1 galUS = 3.7854 L
galUK	UK gallons	1 galk = 4.54609 L
barrel	Barrel (US)	1 barrel = 158.99 L
USER	user unit	1 user unit = USER * L

Index [hex]	Object Name	Definition	Default value	Max Value	Min Value	Length [Bytes]	Data Type	Access
System								
0x0002	SystemCommand	See Table "Comand Codes"				1	UIntegerT	W
Product Identification (Vendor specific parameters)								
0x0010	VendorName		Kobold Messring			max. 20	StringT	R
0x0011	VendorText		www.kobold.com			max. 32	StringT	R
0x0012	ProductName		MIK-XXXXXC3T0			max. 16	StringT	R
0x0013	ProductID		MIK-XXXXXC3T0			max. 16	StringT	R
0x0014	ProductText		MIK-C3T0			max. 32	StringT	R
0x0015	Serialnumber	only read parameter	only read parameter			max. 8	StringT	R
0x0016	HardwareRevision					max. 8	StringT	R
0x0017	FirmwareRevision	Firmware Revision is constant in FW	Firmware Revision is constant in FW			max. 8	StringT	R
0x0018	ApplicationDeviceTag	tag name is from user configurable	tag name is from user configurable			32	StringT	R/W
0x0019	FunctionTag	function tag is from user configurable	function tag is from user configurable			32	StringT	R/W
0x0020	LocationTag	location tag is from user configurable	location tag is from user configurable			32	StringT	R/W
Device Status Information								
0x0024	DeviceStatus	0 - Device OK 1 - Maintenance required 2 - Out of specification 3 - Functional check 4 - Failure				1	UIntegerT	R
0x0025	DetaildDeviceStatus					max. 20	ArrayT of OctetStringT3	R
Display Configuration								
0x0100	DisplayOrientation	Orientation of display	1	(1) - Landscape (2) - Portrait Flip (3) - Landscape Flip (4) - Portrait		1	UIntegerT	R/W
0x0103	DisplayLayout	Single or dual layout	1	(1) - single (2) - dual		1	UIntegerT	R/W
0x0104	UpperDisplay	Source for the upper display	0	(1) - Flow (2) - Volume (3) - Temperature (4) - Part Volume		1	UIntegerT	R/W

0x0105	LowerDisplay	Source for the lower display	2	(1) - Flow (2) - Volume (3) - Temperature (4) - Part Volume	1	UIntegerT	R/W	
0x0106	DisplayRefreshTime	Refresh intervall for the display [s]	0,5	(1) - Off (2) - Value (3) - MinMax	4	FloatT	R/W	
0x010A	LeftHotkeyFunction	Function for left hotkey	0	(1) - Off (2) - Value (3) - MinMax	1	UIntegerT	R/W	
0x010B	RightHotkeyFunction	Function for right hotkey	0	(1) - Flow (2) - Volume (3) - Temperature (4) - Part Volume	1	UIntegerT	R/W	
0x010C	LeftHotkeySource	Source for the left hotkey	0	(1) - Flow (2) - Volume (3) - Temperature (4) - Part Volume	1	UIntegerT	R/W	
0x010D	RightHotkeySource	Source for the right hotkey	0	(1) - low (2) - middle (3) - high	1	UIntegerT	R/W	
0x010E	SensitivityOpticalKeys	Sensitivity for the optical keys	0		1	UIntegerT	R/W	
0x010F	AutomaticMenuLeave	Automatic menu leave if the timeout [s] is hit. 0 = timeout not active	0	60	0	1	UIntegerT	R/W
Output 1 (In IO-Link mode output 1 can be parameterized individual, operating mode can only be changed manually)								
0x0112	OUT2AlarmFunction	Limit or window function for the alarm output	0	(1) - Limit (2) - Window	1	UIntegerT	R/W	
0x0113	OUT2AlarmOutputType	Alarmoutput NPN, PNP or Pushpull	0	(1) - NPN (2) - PNP (3) - PushPull	1	UIntegerT	R/W	
0x0114	OUT2AlarmSwitchFunction	Alarmoutput normally opened or closed	0	(1) - normally opened (2) - normally closed	1	UIntegerT	R/W	
0x0115	OUT2AlarmThreshold [LPM/°C]	Threshold for the alarmoutput	1,0	MRE	MRS	4	FloatT	R/W
0x0119	OUT2AlarmLowerThreshold [LPM/°C]	Threshold for the alarmoutput used by the windowfunction	1,0	OUT2AlarmThreshold	MRS	4	FloatT	R/W
0x011D	OUT2AlarmHysteresis [LPM/°C]	Switching hysteresis for the alarmoutput	1,0	(MRE-MRS)	0,0	4	FloatT	R/W
0x0121	OUT2AlarmSuppressionFactor	How many times the threshold must be hit in order to switch the alarm output	0	60	0	1	UIntegerT	R/W
0x0122	OUT2AlarmSuppressionDirection	for which direction the suppression factor is used	0	(1) - Up (2) - Down (3) - Both	1	UIntegerT	R/W	

0x0124	OUT2AnalogNamurStandard	If enabled (1) the analog output conforms with the NAMUR Standard NE42. If disabled (0) the analog output stays in his equivalent range (e.g. 4-20mA)	1		(1) - NAMUR disabled (2) - NAMUR enabled	1	UIntegerT	R/W
0x0125	OUT2AnalogValue0mA	The value from the slot used for the 0mA scaling point [LPM/°C]	0,0	OUT2AnalogValue20mA	MRS	4	FloatT	R/W
0x0129	OUT2AnalogValue4mA	The value from the slot used for the 4mA scaling point [LPM/°C]	0,0	OUT2AnalogValue20mA	MRS	4	FloatT	R/W
0x012D	OUT2AnalogValue20mA	The value from the slot used for the 20mA scaling point [LPM/°C]	100,0	MRE	OUT2AnalogValue0mA	4	FloatT	R/W
0x0131	OUT2AnalogValue0V	The value from the slot used for the 0V scaling point [LPM/°C]	0,0	OUT2AnalogValue10V	MRS	4	FloatT	R/W
0x0135	OUT2AnalogValue2V	The value from the slot used for the 2V scaling point [LPM/°C]	0,0	OUT2AnalogValue10V	MRS	4	FloatT	R/W
0x0139	OUT2AnalogValue10V	The value from the slot used for the 10V scaling point [LPM/°C]	100,0	MRE	OUT2AnalogValue0V	4	FloatT	R/W
0x0150	OUT2PulseVolume	The volume represented by one pulse [L]	1,0	999,9	0,000001	4	FloatT	R/W
0x0154	OUT2PulseVolumeUnit	Unit used for the pulse output	1	(1) - USER (2) - L (3) - mL (3) - m3 (4) - galUS (5) - galUK (6) - Barrel		1	UIntegerT	R/W
0x0155	OUT2PulseVolumeUnitUser	User Unit used for the pulse output	1,0	9999,9	0,001	4	FloatT	R/W
0x0159	OUT2PulseWidth	The width of each pulse [ms]	1	20000	1	2	UIntegerT	R/W
0x015B	OUT2FrequencyatFS	The max. frequency for the output [Hz]	500	1000	50	2	UIntegerT	R/W
0x015D	OUT2FrequencyOverflow	The overflow frequency of the max frequency [%]	1	100	0	1	UIntegerT	R/W
0x015E	OUT2FrequencyValue0Hz	The value from the slot used for the 0Hz scaling point [LPM/°C]	0,0	OUT2FrequencyValueMaxHz	MRS	4	FloatT	R/W
0x0162	OUT2FrequencyValueMaxHz	The value from the slot used for the max Hz scaling point [LPM/°C]	100,0	MRE	OUT2FrequencyValue0Hz	4	FloatT	R/W

0x0166	OUT1CtrlFunction	Controlinputfunction -> Off or Memoryreset	0	1	0	1	UInteg erT	R/W
Output 2								
0x0177	OUT2Source	Source for the output	0	(1) - Flow (2) - Volume (3) - Temperature (4) - Part Volume		1	UInteg erT	R/W
0x0178	OUT2Type	Configuration of the output -> 0-20mA, Pulse, Frequency, etc.	0	(1) - disabled (2) - Alarm Output (2) - 4-20mA (3) - 0-20mA (4) - 2-10V (5) - 0-10V (6) - Pulse Output (7) - Frequency Output		1	UInteg erT	R/W
0x0179	OUT2AlarmFunction	Limit or window function for the alarm output	0	(1) - Limit (2) - Window		1	UInteg erT	R/W
0x017A	OUT2AlarmOutputType	Alarmoutput NPN, PNP or Pushpull	0	(1) - NPN (2) - PNP (3) - PushPull		1	UInteg erT	R/W
0x017B	OUT2AlarmSwitchFunction	Alarmoutput normally opened or closed	0	(1) - normally opened (2) - normally closed		1	UInteg erT	R/W
0x017C	OUT2AlarmThreshold [LPM/°C]	Threshold for the alarmoutput	1,0	MRE	MRS	4	FloatT	R/W
0x0180	OUT2AlarmLowerThre shold [LPM/°C]	Threshold for the alarmoutput used by the windowfunction	1,0	OUT2Alarm Threshold	MRS	4	FloatT	R/W
0x0184	OUT2AlarmHysteresis [LPM/°C]	Switching hysteresis for the alarmoutput	1,0	(MRE-MRS)	0,0	4	FloatT	R/W
0x0188	OUT2AlarmSuppressio nFactor	How many times the threshold must be hit in order to switch the alarm output	0	60	0	1	UInteg erT	R/W
0x0189	OUT2AlarmSuppressio nDirection	for which direction the suppression factor is used	0	(1) - Up (2) - Down (3) - Both		1	UInteg erT	R/W
0x018B	OUT2AnalogNamurSta ndard	If enabled (1) the analogoutput conforms with the NAMUR Standard NE42. If disabled (0) the analogoutput stays in his equivalent range (e.g. 4-20mA)	1	(1) - NAMUR disabled (2) - NAMUR enabled		1	UInteg erT	R/W
0x018C	OUT2AnalogValue0mA	The value from the slot used for the 0mA scaling point [LPM/°C]	0,0	OUT2Analo g Value20mA	MRS	4	FloatT	R/W
0x0190	OUT2AnalogValue4mA	The value from the slot used for the 4mA scaling point [LPM/°C]	0,0	OUT2Analo g Value20mA	MRS	4	FloatT	R/W

0x0194	OUT2AnalogValue20mA	The value from the slot used for the 20mA scaling point [LPM/°C]	100,0	MRE	OUT2AnalogValue0mA	4	FloatT	R/W
0x0198	OUT2AnalogValue0V	The value from the slot used for the 0V scaling point [LPM/°C]	0,0	OUT2AnalogValue10V	MRS	4	FloatT	R/W
0x019C	OUT2AnalogValue2V	The value from the slot used for the 2V scaling point [LPM/°C]	0,0	OUT2AnalogValue10V	MRS	4	FloatT	R/W
0x01A0	OUT2AnalogValue10V	The value from the slot used for the 10V scaling point [LPM/°C]	100,0	MRE	OUT2AnalogValue0V	4	FloatT	R/W
0x01B7	OUT2PulseVolume	The volume represented by one pulse [L]	1,0	999,9	0,000001	4	FloatT	R/W
0x01BB	OUT2PulseVolumeUnit	Unit used for the pulse output	1	(1) - USER (2) - L (3) - mL (3) - m3 (4) - galUS (5) - galUK (6) - Barrel		1	UIntegerT	R/W
0x01BC	OUT2PulseVolumeUnitUser	User Unit used for the pulse output	1,0	9999,9	0,001	4	FloatT	R/W
0x01C0	OUT2PulseWidth	The width of each pulse [ms]	1	20000	1	2	UIntegerT	R/W
0x01C2	OUT2FrequencyatFS	The max. frequency for the output [Hz]	500	1000	50	2	UIntegerT	R/W
0x01C4	OUT2FrequencyOverflow	The overflow frequency of the max frequency [%]	1	100	0	1	UIntegerT	R/W
0x01C5	OUT2FrequencyValue0Hz	The value from the slot used for the 0Hz scaling point [LPM/°C]	0,0	OUT2FrequencyValueMaxHz	MRS	4	FloatT	R/W
0x01C9	OUT2FrequencyValueMaxHz	The value from the slot used for the max Hz scaling point [LPM/°C]	100,0	MRE	OUT2FrequencyValue0Hz	4	FloatT	R/W
Dosing								
0x01DE	DosingValue	Dosingvalue [L]	0,0	9999,9	0,0	4	FloatT	R/W
0x01E2	DosingCorrectionValue	Correction value which is added to the dosing value for the complete dosing counter [L]	0,0	Dosing Value	minus Dosing Value	4	FloatT	R/W
0x01E6	DosingUnit	Unit used for the dosing function	1	(1) - USER (2) - L (3) - mL (3) - m3 (4) - galUS (5) - galUK (6) - Barrel		1	UIntegerT	R/W
0x01E7	DosingUnitUser	User Unit used for the dosing function	1,0	9999,9	0,001	4	FloatT	R/W

0x01EB	DosingTimeout	Timeout [s] for no flow	0,5	10,0	0,5	4	FloatT	R/W
0x01EF	DosingCounter	Saved dosing volume counter stats	0,0	999999,0	-999999,0	4	FloatT	R
Service								
0x01F3	ServiceUserPassword	Password for user service menu and main menu	0	99999	0	4	UIntegerT	R/W
0x01F7	ServiceUserMenuLocked	Whether main menu is locked or not	0	(1) - not locked (2) - locked		1	UIntegerT	R/W
0x01F8	SimulationAutoStop	Auto stop for Simulation after time [min]	10	31	1	1	UIntegerT	R/W
Misc								
0x01FA	LanguageSelection	Language selection	0	(1) - English (2) - German (3) - French (4) - Spanish		1	UIntegerT	R/W
0x028A	OperatingHoursCount	Operating hours counter	0	4294967296	0	4	UIntegerT	R
0x028F	ProductionProductVariantName	Product Variant Name	MIK			16	StringT	R
0x029F	ProductionProductTypeKey	Product Type Key	MIK-XXXXXC3T0			16	StringT	R
Flow								
0x02F5	CutOff	Cut off for flow value [LPM]	0,0	MRE	0.0	4	FloatT	R/W
0x02F9	Unit	Unit used for flow	1	(1) - USER (2) - L/m (3) - mL/m (4) - L/h (4) - m3/h (5) - galUS/m (6) - galUS/h (7) - galUK/m (8) - galUK/h (9) - L/s (10) - mL/s		1	UIntegerT	R/W
0x02FA	UserUnit	User Unit used for flow	1,0	9999,9	0,001	4	FloatT	R/W
0x0313	SimMode	Mode of the Simulation: Static, Triangle or Monotonic	0	(1) - Static (2) - Triangle (3) - Monotonic		1	UIntegerT	R/W
0x0314	SimStartValue	Value to start with the simulation [LPM]	0,0	99999,99	-99999,99	4	FloatT	R/W
0x0318	SimIncrementValue	Incrementation value of the simulation [LPM]	10,0	99999,99	-99999,99	4	FloatT	R/W
0x031C	SimNumberIntervals	Number of intervals to simulation	20	65000	1	2	UIntegerT	R/W
0x031E	SimTimingIntervals	Timinig in ms between intervals	50	50000	10	2	UIntegerT	R/W
0x0320	ValueInSiUnit	Saved flow value in SI unit [LPM]	0,0	999999,0	-999999,0	4	FloatT	R
0x0324	MinValueInSiUnit	Saved min flow value in SI unit [LPM]	0,0	999999,0	-999999,0	4	FloatT	R

0x0328	MaxValueInSiUnit	Saved max flow value in SI unit [LPM]	0,0	999999,0	-999999,0	4	FloatT	R
Volume								
0x0358	CountingType	counting type for a volume slot -> absolute or bidirectional	0	(1) - absolute (2) - bidirectional		1	UIntegerT	R/W
0x035D	Unit	Unit used for volume	1	(1) - USER (2) - L (3) - mL (3)- m3 (4) - galUS (5) - galUK (6) - Barrel		1	UIntegerT	R/W
0x035E	UserUnit	User Unit used for volume	1,0	9999,9	0,001	4	FloatT	R/W
0x0384	ValueInSiUnit	Saved volume value in SI unit	0,0	999999,0	-999999,0	4	FloatT	R
Temperature								
0x03C1	Unit	Unit used for temperature	1	(0) - USER (1) - °C (2) - °F		1	UIntegerT	R/W
0x03C2	UserUnit	User Unit used for temperature [°C]	1,0	9999,9	0,001	4	FloatT	R/W
0x03DB	SimMode	Mode of the Simulation: Static, Triangle or Monotonic	0	(1) - Static (2) - Triangle (3) - Monotonic		1	UIntegerT	R/W
0x03DC	SimStartValue	Value to start with the simulation [°C]	0,0	99999,99	-99999,99	4	FloatT	R/W
0x03E0	SimIncrementValue	Incrementation value of the simulation [°C]	10,0	99999,99	-99999,99	4	FloatT	R/W
0x03E4	SimNumberIntervals	Number of intervals to simulation	20	65000	1	2	UIntegerT	R/W
0x03E6	SimTimingIntervals	Timinig in ms between intervals [ms]	50	50000	10	2	UIntegerT	R/W
0x03E8	ValueInSiUnit	Saved temperature value in SI unit [°C]	0,0	999999,0	-999999,0	4	FloatT	R
0x03EC	MinValueInSiUnit	Saved min temperature value in SI unit [°C]	0,0	999999,0	-999999,0	4	FloatT	R
0x03F0	MaxValueInSiUnit	Saved max temperature value in SI unit [°C]	0,0	999999,0	-999999,0	4	FloatT	R
Part Volume								
0x0420	CountingType	counting type for a volume slot -> absolute or bidirectional	0	(1) - absolute (2) - bidirectional		1	UIntegerT	R/W
0x0425	Unit	Unit used for part volume	1	(1) - USER (2) - L (3) - mL (3)- m3 (4) - galUS (5) - galUK (6) - Barrel		1	UIntegerT	R/W





0x0426	UserUnit	User Unit used for part volume	1,0	9999,9	0,001	4	FloatT	R/W
0x043F	SimMode	Mode of the Simulation: Static, Triangle or Monotonic	0	(1) - Static (2) - Triangle (3) - Monotonic		1	UIntegerT	R/W
0x0440	SimStartValue	Value to start with the simulation	0,0	99999,99	-99999,99	4	FloatT	R/W
0x0444	SimIncrementValue	Incrementation value of the simulation	10,0	99999,99	-99999,99	4	FloatT	R/W
0x0448	SimNumberIntervals	Number of intervals to simulation	20	65000	1	2	UIntegerT	R/W
0x044A	SimTimingIntervals	Timing in ms between intervals	50	50000	10	2	UIntegerT	R/W
0x044C	ValueInSiUnit	Saved part volume value in SI unit	0,0	999999,0	-999999,0	4	FloatT	R

Legend

MRE Measuring Range End

MRS Measuring Range Start

19. Manufacturer's declaration

	
<p>MANUFACTURER'S DECLARATION OF CONFORMITY</p>	
<p>We:</p> <p>Kobold Messring GmbH Nordring 22-24 65719 Hofheim Germany</p>	
<p>declare under our own responsibility that the product(s):</p>	
<p>MIK-****C3T0 IO-Link Device</p>	
<p>to which this declaration refers conform to:</p>	
<p><input checked="" type="checkbox"/> IO-Link Interface and System Specification, V1.1.3, June 2019 (NOTE 1,2)</p> <p><input checked="" type="checkbox"/> IO Device Description, V1.1.3, January 2021</p> <p><input checked="" type="checkbox"/> Additional conformance to Device Profiles (If checked refer to Part A on page 2)</p> <p><input type="checkbox"/> Conformance exceptions (If checked refer to Part B on page 2)</p>	
<p>The conformity tests are documented in the test report(s):</p>	
<p><i>IO-Link_Device_Test_Report_MIK-C3T0_20231201.pdf</i></p>	
<p>Issued at Hofheim, 12.01.2023</p>	
<p>Authorized signatory</p>	
<p>Name: Hans Volz</p> <p>Title: <i>General Manager</i></p> <p>Signature: </p>	<p>Name: Manfred Wenzel</p> <p>Title: <i>Proxy Holder</i></p> <p>Signature: </p>
<p><small>Reproduction and all distribution without written authorization prohibited</small></p>	
<p>NOTE 1 Relevant Test specification is V1.1.3, January 2021</p> <p>NOTE 2 Additional validity in Package 2020 and Corrigendum</p>	<p>MD-Version: V1.1.3 / 2022-01</p>

Part A - Additional conformance to Device Profiles

	Specification
<input checked="" type="checkbox"/>	IO-Link Common Profile Specification, V1.1, Dec. 2021
<input type="checkbox"/>	IO-Link Profile BLOB Transfer & Firmware Update Specification, V1.1, Sept. 2019
<input type="checkbox"/>	IO-Link Smart Sensors 2 nd Edition Specification, V1.1, Sept. 2021

Part B - Conformance exceptions

We herewith declare the following deviations to the related specifications	Reason
none	-

20. EU Declaration of Conformance

We, KOBOLD Messring GmbH, Nordring 22-24, 65719 Hofheim, Germany, declare under our sole responsibility that the product:

Compact Magnetic-Inductive Flow Meter Model: MIK-...

to which this declaration relates is in conformity with the following UK directives stated below:

2014/30/EU	EMC Directive
2011/65/EU	RoHS (category 9)
2015/863/EU	Delegated Directive (RoHS III)

Also, the following standards are fulfilled:

EN IEC 61326-1:2021

Electrical equipment for measurement, control and laboratory use - EMC requirements - Part 1: General requirements, Industrial area

Restriction: measurement of immunity to HF field with electronics options L/F/S/K/E/G up to 1 GHz

EN IEC 63000:2018

Technical documentation for the assessment of electrical and electronic products with respect to the restriction of hazardous substances

Hofheim, 10 Oktober 2023

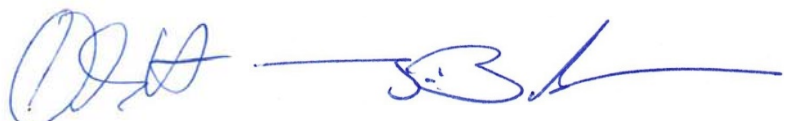

H. Volz
General Manager

J. Burke
Compliance Manager

21. UK Declaration of Conformity

We, KOBOLD Messring GmbH, Nordring 22-24, 65719 Hofheim, Germany, declare under our sole responsibility that the product:

Compact Magnetic-Inductive Flow Meter Model: MIK-...

to which this declaration relates is in conformity with the following UK directives stated below:

S.I. 2016/1091 Electromagnetic Compatibility Regulations 2016
**S.I. 2012/3032 The Restriction of the Use of Certain Hazardous
Substances in Electrical and Electronic Equipment
Regulations 2012**

Also, the following standards are fulfilled:

BS EN IEC 61326-1:2021

Electrical equipment for measurement, control and laboratory use. EMC requirements. General requirements, Industrial area

Restriction: measurement of immunity to HF field with electronics options L/F/S/K/E/G up to 1 GHz

BS EN IEC 63000:2018

Technical documentation for the assessment of electrical and electronic products with respect to the restriction of hazardous substances.

Hofheim, 10. Oktober 2023



H. Volz
General Manager

J. Burke
Compliance Manager